

2SA1533

Silicon PNP epitaxial planer type

For low-frequency driver amplification

Complementary to 2SC3939

Features

- High collector to emitter voltage V_{CEO} .
- Optimum for the driver stage of a low-frequency and 25 to 30W output amplifier.

Absolute Maximum Ratings (Ta=25°C)

Parameter	Symbol	Ratings	Unit
Collector to base voltage	V_{CBO}	-80	V
Collector to emitter voltage	V_{CEO}	-80	V
Emitter to base voltage	V_{EBO}	-5	V
Peak collector current	I_{CP}	-1	A
Collector current	I_C	-0.5	A
Collector power dissipation	P_C	1	W
Junction temperature	T_j	150	°C
Storage temperature	T_{stg}	-55 ~ +150	°C

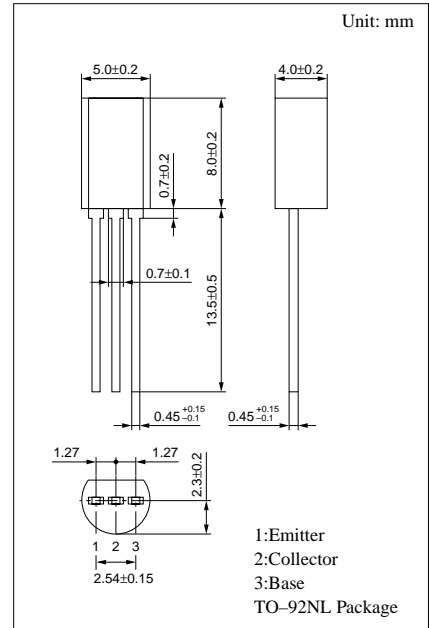

Electrical Characteristics (Ta=25°C)

Parameter	Symbol	Conditions	min	typ	max	Unit
Collector cutoff current	I_{CBO}	$V_{CB} = -20V, I_E = 0$			-0.1	μA
Collector to base voltage	V_{CBO}	$I_C = -10\mu A, I_E = 0$	-80			V
Collector to emitter voltage	V_{CEO}	$I_C = -100\mu A, I_B = 0$	-80			V
Emitter to base voltage	V_{EBO}	$I_E = -10\mu A, I_C = 0$	-5			V
Forward current transfer ratio	h_{FE1}^*	$V_{CE} = -10V, I_C = -150mA$	90		220	
	h_{FE2}	$V_{CE} = -5V, I_C = -500mA$	50	100		
Collector to emitter saturation voltage	$V_{CE(sat)}$	$I_C = -300mA, I_B = -30mA$		-0.2	-0.4	V
Base to emitter saturation voltage	$V_{BE(sat)}$	$I_C = -300mA, I_B = -30mA$		-0.85	-1.2	V
Transition frequency	f_T	$V_{CB} = -10V, I_E = 50mA, f = 200MHz$		85		MHz
Collector output capacitance	C_{ob}	$V_{CB} = -10V, I_E = 0, f = 1MHz$		11	20	pF

* h_{FE1} Rank classification

Rank	Q	R
h_{FE1}	90 ~ 155	130 ~ 220

$P_C - T_a$

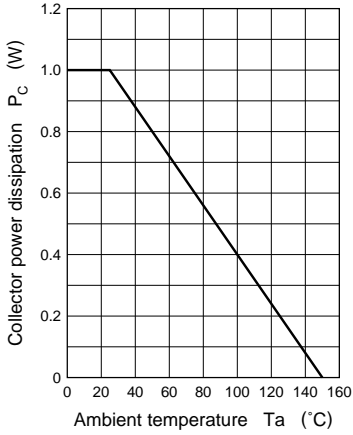

$I_C - V_{CE}$

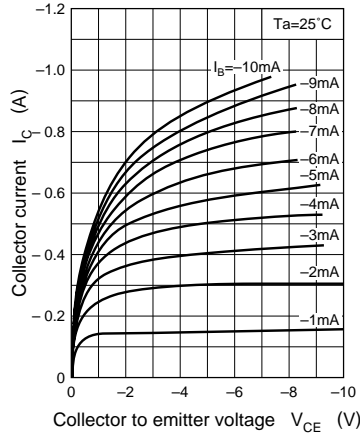

$I_C - I_B$

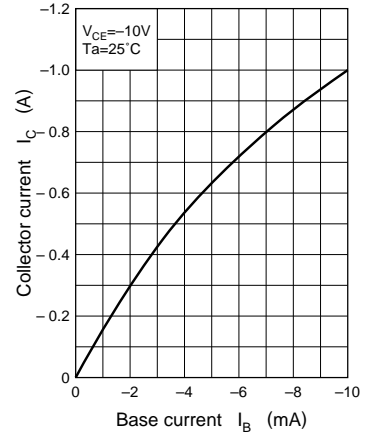

$V_{CE(sat)} - I_C$

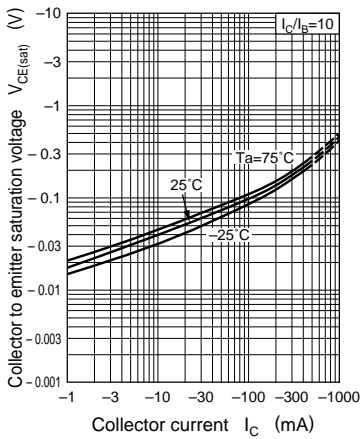

$V_{BE(sat)} - I_C$

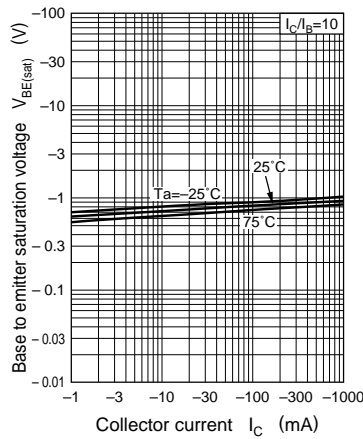

$h_{FE} - I_C$

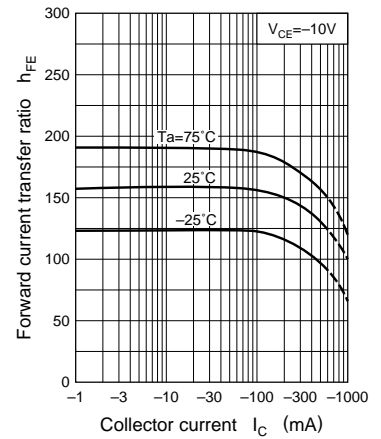

$f_T - I_E$

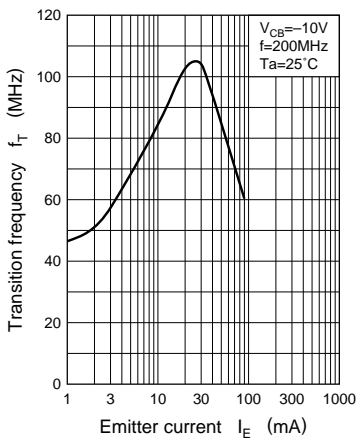

$C_{ob} - V_{CB}$

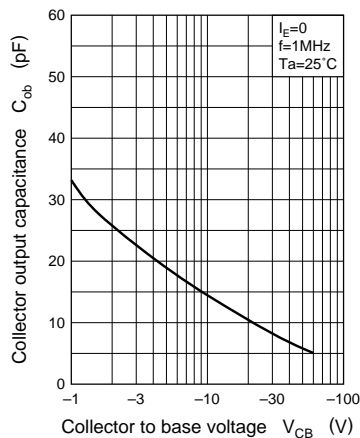

$I_{CBO} - T_a$

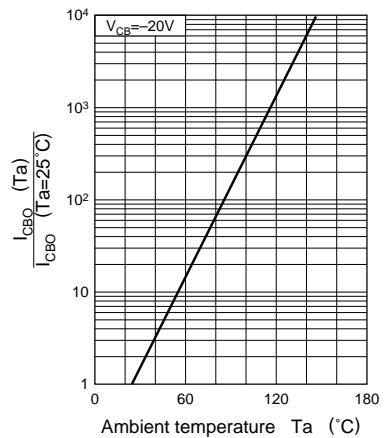

$I_{CEO} - T_a$

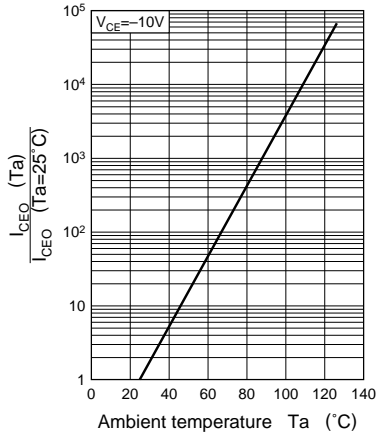

Area of safe operation (ASO)

