



2SC1384

NPN SILICON TRANSISTOR

NPN SILICON TRANSISTOR

DESCRIPTION

The UTC **2SC1384** is power amplifier and driver.

FEATURES

* Low $V_{CE(SAT)}$

* 2~3W output in complementary pair with 2SA684

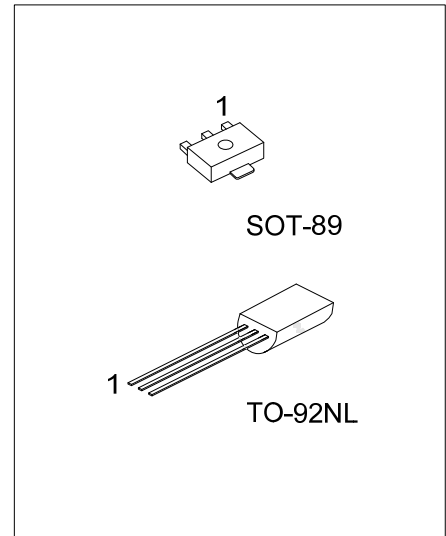

Lead-free: 2SC1384L

Halogen-free: 2SC1384G

ORDERING INFORMATION

Ordering Number			Package	Pin Assignment			Packing
Normal	Lead Free Plating	Halogen-Free		1	2	3	
2SC1384-x-AB3-R	2SC1384L-x-AB3-R	2SC1384G-x-AB3-R	SOT-89	B	C	E	Tape Reel
2SC1384-x-T9N-B	2SC1384L-x-T9N-B	2SC1384G-x-T9N-B	TO-92NL	E	C	B	Tape Box
2SC1384-x-T9N-K	2SC1384L-x-T9N-K	2SC1384G-x-T9N-K	TO-92NL	E	C	B	Bulk
2SC1384-x-T9N-R	2SC1384L-x-T9N-R	2SC1384G-x-T9N-R	TO-92NL	E	C	B	Tape Reel

<p>2SC1384L-x-AB3-B</p> <p>(1) Packing Type (2) Package Type (3) Rank (4) Lead Plating</p>	<p>(1) K: Bulk, T: Tube, R: Tape Reel (2) AB3: SOT-89, T9N: TO-92NL (3) x: refer to Classification of h_{FE} (4) G: Halogen Free, L: Lead Free Plating, Blank: Pb/Sn</p>
--	---

■ ABSOLUTE MAXIMUM RATINGS (Ta=25°C, unless otherwise specified)

PARAMETER	SYMBOL	RATINGS	UNIT
Collector-Base Voltage	V _{CBO}	60	V
Collector-Emitter Voltage	V _{CEO}	50	V
Emitter-Base Voltage	V _{EBO}	5	V
Peak Collector Current	I _{CP}	1.5	A
Collector Current (DC)	I _C	1	A
Collector Dissipation (Ta=25°C)	P _C	1000	mW
Junction Temperature	T _J	125	°C
Operating Temperature	T _{OPR}	-20 ~ +85	°C
Storage Temperature	T _{STG}	-40 ~ +150	°C

Note: Absolute maximum ratings are those values beyond which the device could be permanently damaged.

Absolute maximum ratings are stress ratings only and functional device operation is not implied.

■ ELECTRICAL CHARACTERISTICS (Ta=25°C, unless otherwise specified)

PARAMETER	SYMBOL	TEST CONDITIONS	MIN	TYP	MAX	UNIT
Collector-Base Breakdown Voltage	BV _{CBO}	I _C =10μA, I _E =0	60			V
Collector-Emitter Breakdown Voltage	BV _{CEO}	I _C =2mA, I _B =0	50			V
Emitter-Base Breakdown Voltage	BV _{EBO}	I _E =10μA, I _C =0	5			V
Collector Cut-Off Current	I _{CBO}	V _{CB} =20V, I _E =0			0.1	μA
DC Current Gain	h _{FE1}	V _{CE} =10V, I _C =500mA	85	160	340	
	h _{FE2}	V _{CE} =5V, I _B =1A	50	100		
Collector-Emitter Saturation Voltage	V _{CE(SAT)}	I _C =0.5A, I _B =50mA		0.2	0.4	V
Base-Emitter Saturation Voltage	V _{BE(SAT)}	I _C =0.5A, I _B =50mA		0.85	1.2	V
Current Gain Bandwidth Product	f _T	V _{CE} =10V, I _B =50mA		200		MHz
Output Capacitance	C _{ob}	V _{CB} =10V, I _E =0, f=1MHz		11	20	pF

■ CLASSIFICATION OF h_{FE}

RANK	Q	R	S
RANGE	85-170	120-240	170-340

TYPICAL CHARACTERISTICS

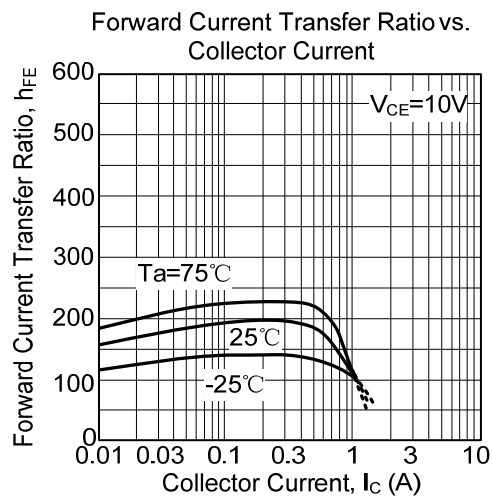
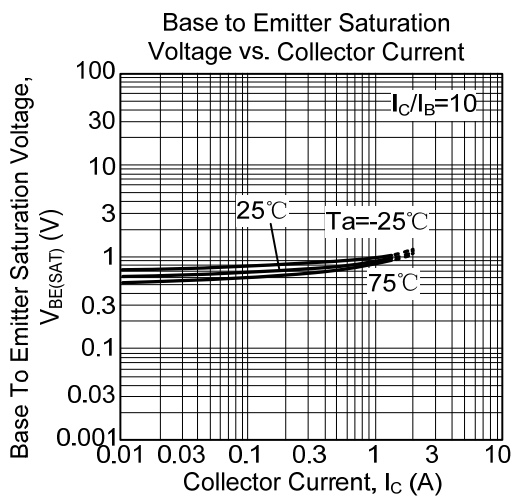
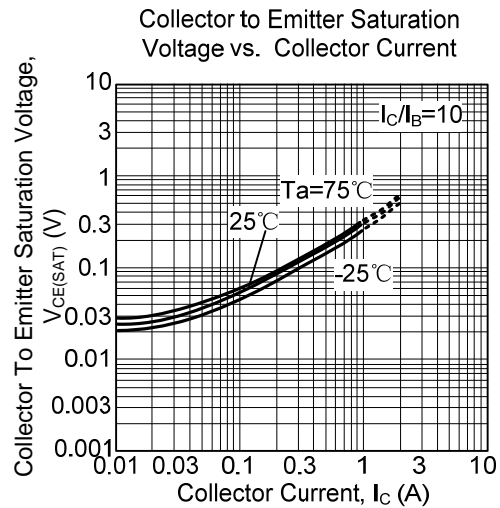
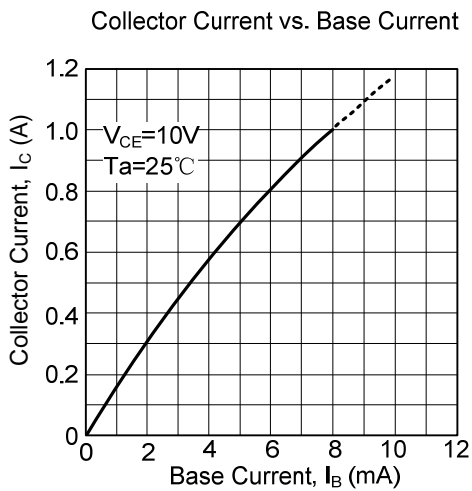
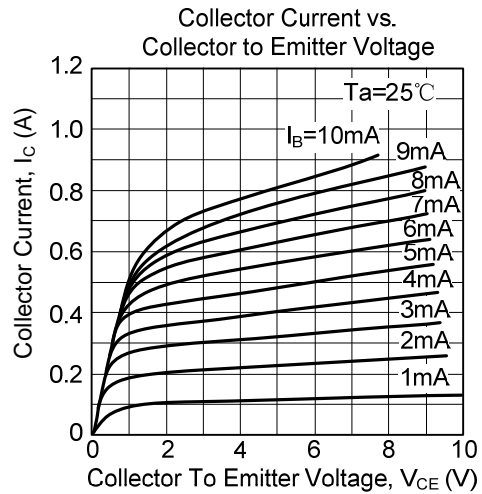
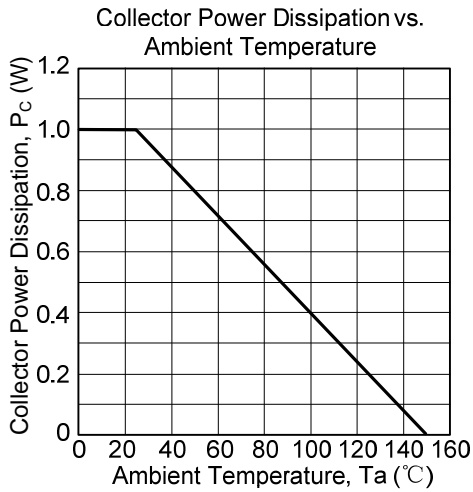

■ TYPICAL CHARACTERISTICS(Cont.)

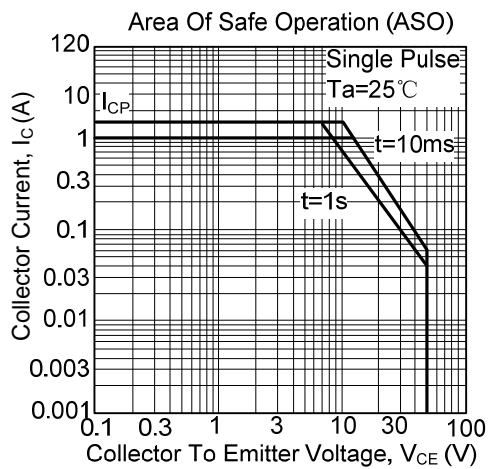
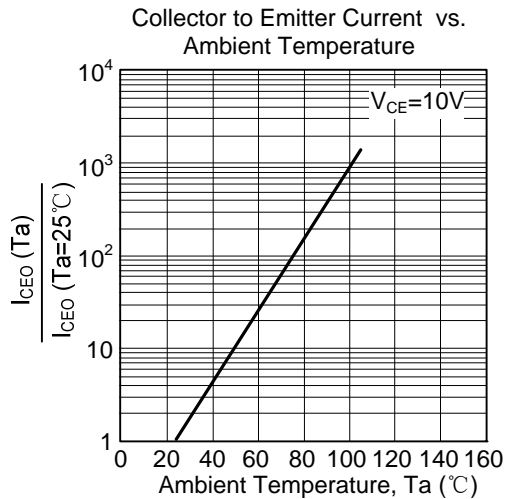
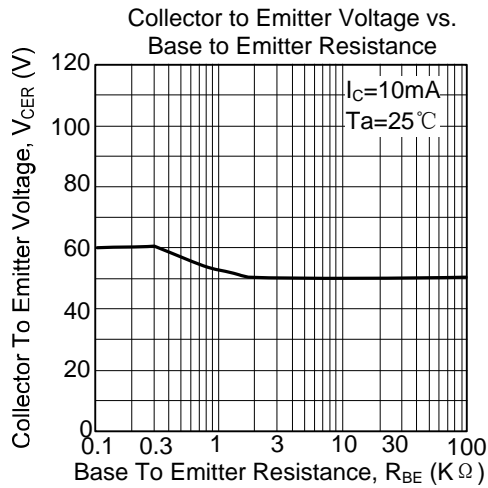
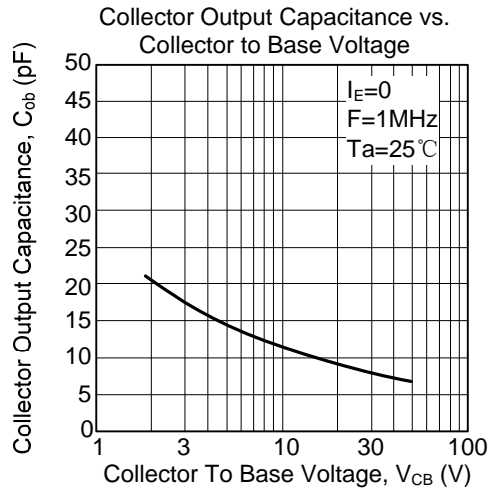
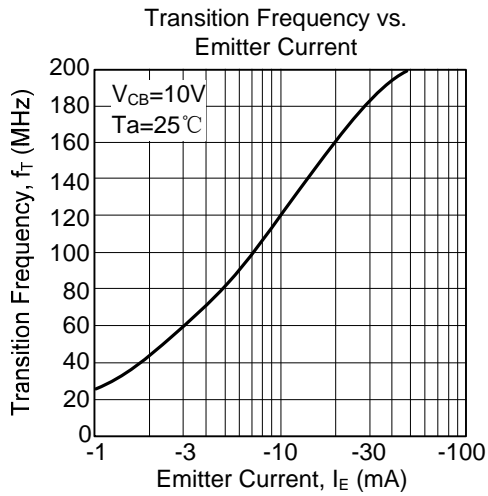

UTC assumes no responsibility for equipment failures that result from using products at values that exceed, even momentarily, rated values (such as maximum ratings, operating condition ranges, or other parameters) listed in products specifications of any and all UTC products described or contained herein. UTC products are not designed for use in life support appliances, devices or systems where malfunction of these products can be reasonably expected to result in personal injury. Reproduction in whole or in part is prohibited without the prior written consent of the copyright owner. The information presented in this document does not form part of any quotation or contract, is believed to be accurate and reliable and may be changed without notice.