

# DATA SHEET

For a complete data sheet, please also download:

- The IC04 LOCMOS HE4000B Logic Family Specifications HEF, HEC
- The IC04 LOCMOS HE4000B Logic Package Outlines/Information HEF, HEC

## **HEF4528B**

## **MSI**

## **Dual monostable multivibrator**

Product specification  
File under Integrated Circuits, IC04

January 1995

# Dual monostable multivibrator

# HEF4528B MSI

**DESCRIPTION**

The HEF4528B is a dual retriggerable-resettable monostable multivibrator. Each multivibrator has an active LOW input ( $\bar{I}_0$ ), and active HIGH input ( $I_1$ ), an active LOW clear direct input ( $\bar{C}_D$ ), an output (O) and its complement ( $\bar{O}$ ), and two pins for connecting the external timing components ( $C_{TC}^{(1)}$ ,  $RC_{TC}$ ).

An external timing capacitor ( $C_t$ ) must be connected between  $C_{TC}$  and  $RC_{TC}$  and an external resistor ( $R_t$ ) must be connected between  $RC_{TC}$  and  $V_{DD}$ . The duration of the

(1) Always connected to ground.

output pulse is determined by the external timing components  $C_t$  and  $R_t$ .

A HIGH to LOW transition on  $\bar{I}_0$  when  $I_1$  is LOW or a LOW to HIGH transition on  $I_1$  when  $\bar{I}_0$  is HIGH produces a positive pulse (LOW-HIGH-LOW) and O and a negative pulse (HIGH-LOW-HIGH) on  $\bar{O}$  if the  $\bar{C}_D$  is HIGH. A LOW

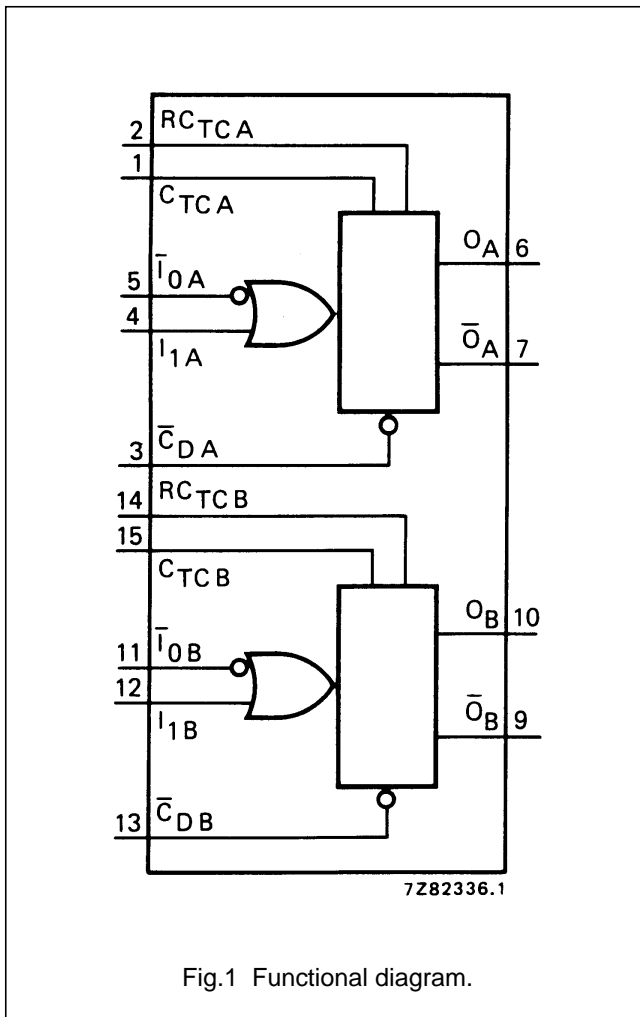

Fig.1 Functional diagram.

on  $\bar{C}_D$  forces O LOW, O HIGH and inhibits any further pulses until  $\bar{C}_D$  is HIGH.

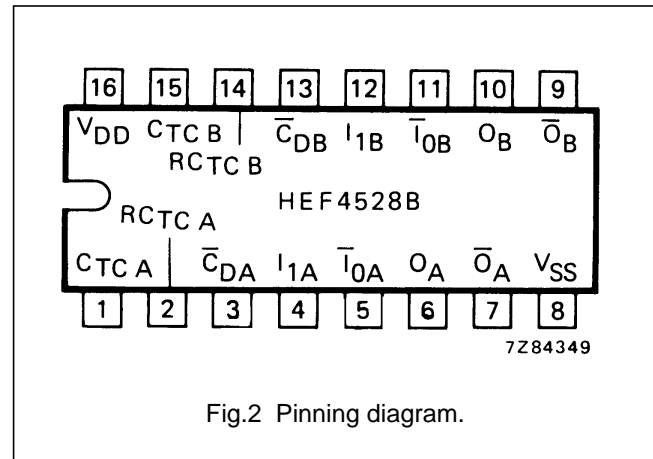

Fig.2 Pinning diagram.

- HEF4528BP(N): 16-lead DIL; plastic (SOT38-1)
- HEF4528BD(F): 16-lead DIL; ceramic (cerdip) (SOT74)
- HEF4528BT(D): 16-lead SO; plastic (SOT109-1)
- ( ): Package Designator North America

**PINNING**

- $\bar{I}_{0A}, \bar{I}_{0B}$  input (HIGH to LOW triggered)
- $I_{1A}, I_{1B}$  input (LOW to HIGH triggered)
- $\bar{C}_{DA}, \bar{C}_{DB}$  clear direct input (active LOW)
- $O_A, O_B$  output
- $\bar{O}_A, \bar{O}_B$  complementary output (active LOW)
- $C_{TC A}, C_{TC B}$  external capacitor connections <sup>(1)</sup>
- $RC_{TC A}, RC_{TC B}$  external capacitor/ resistor connections

**FAMILY DATA, I<sub>DD</sub> LIMITS category MSI**

See Family Specifications

Dual monostable multivibrator

HEF4528B  
MSI

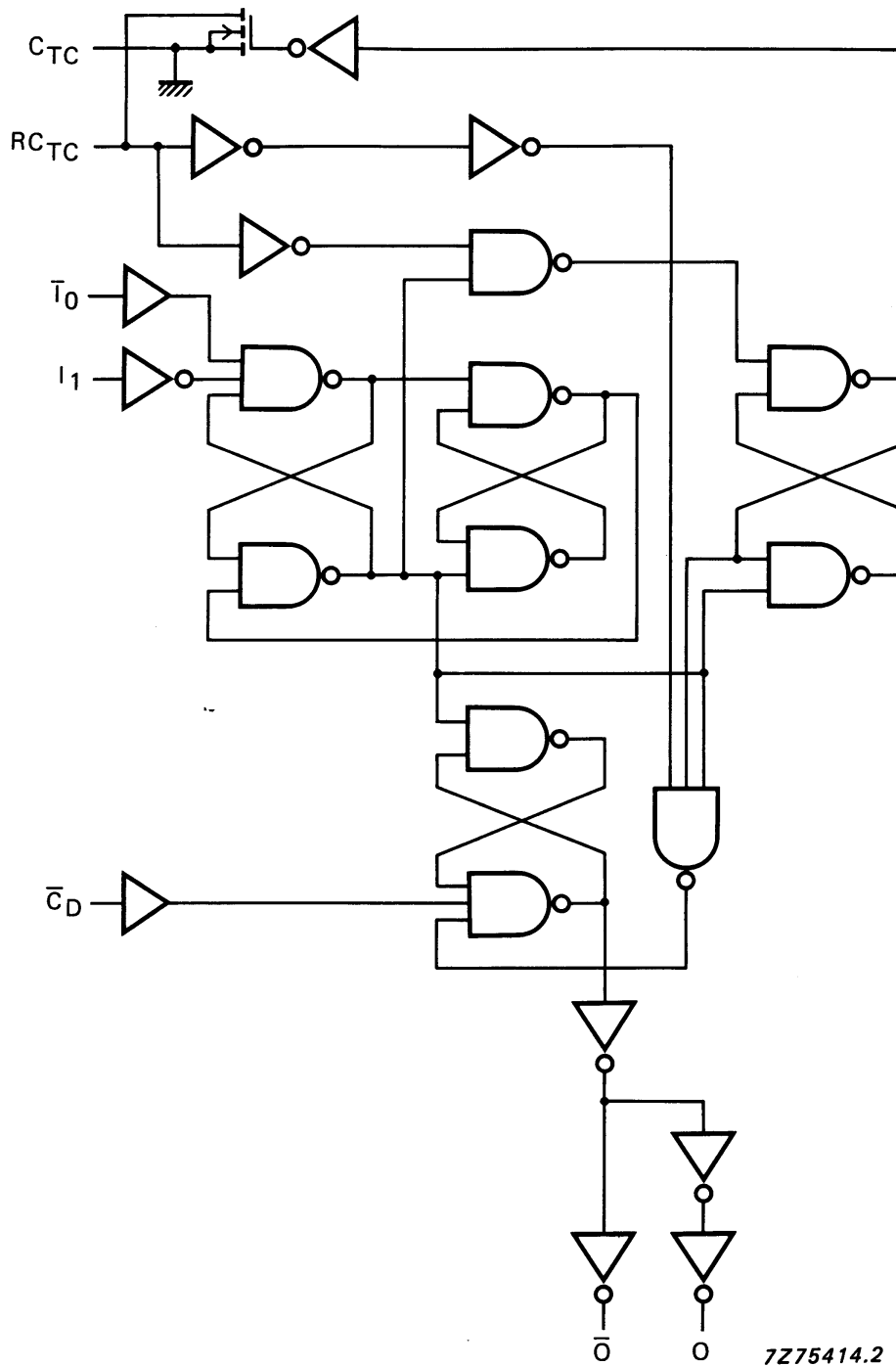







Fig.3 Logic diagram (one monostable multivibrator).





## Dual monostable multivibrator

HEF4528B  
MSI

## FUNCTION TABLE

INPUTS			OUTPUTS	
$\bar{I}_0$	$I_1$	$\bar{C}_D$	O	$\bar{O}$
	L	H		
H		H		
X	X	L	L	H

## Notes

1. H = HIGH state (the more positive voltage)
2. L = LOW state (the less positive voltage)
3. X = state is immaterial
4.  = positive-going transition
5.  = negative-going transition
6.   = positive or negative output pulse; width is determined by  $C_t$  and  $R_t$

## AC CHARACTERISTICS

 $V_{SS} = 0$  V;  $T_{amb} = 25$  °C;  $C_L = 50$  pF; input transition times  $\leq 20$  ns

	$V_{DD}$ V	SYMBOL	MIN.	TYP.	MAX.	TYPICAL EXTRAPOLATION FORMULA	
Propagation delays $\bar{I}_0, I_1 \rightarrow \bar{O}$ HIGH to LOW $\bar{I}_0, I_1 \rightarrow O$ LOW to HIGH $\bar{C}_D \rightarrow O$ HIGH to LOW $\bar{C}_D \rightarrow \bar{O}$ LOW to HIGH	5			140	280	ns	113 ns + (0,55 ns/pF) $C_L$
	10	$t_{PHL}$		50	100	ns	39 ns + (0,23 ns/pF) $C_L$
	15			35	70	ns	27 ns + (0,16 ns/pF) $C_L$
	5			155	305	ns	128 ns + (0,55 ns/pF) $C_L$
	10	$t_{PLH}$		60	115	ns	49 ns + (0,23 ns/pF) $C_L$
	15			40	80	ns	32 ns + (0,16 ns/pF) $C_L$
	5			105	210	ns	78 ns + (0,55 ns/pF) $C_L$
	10	$t_{PHL}$		40	85	ns	29 ns + (0,23 ns/pF) $C_L$
	15			30	60	ns	22 ns + (0,16 ns/pF) $C_L$
Output transition times HIGH to LOW LOW to HIGH	5			60	120	ns	10 ns + (1,0 ns/pF) $C_L$
	10	$t_{THL}$		30	60	ns	9 ns + (0,42 ns/pF) $C_L$
	15			20	40	ns	6 ns + (0,28 ns/pF) $C_L$
	5			60	120	ns	10 ns + (1,0 ns/pF) $C_L$
	10	$t_{TLH}$		30	60	ns	9 ns + (0,42 ns/pF) $C_L$
	15			20	40	ns	6 ns + (0,28 ns/pF) $C_L$

## Dual monostable multivibrator

HEF4528B  
MSI**AC CHARACTERISTICS** $V_{SS} = 0\text{ V}$ ;  $T_{amb} = 25\text{ °C}$ ; input transition times  $\leq 20\text{ ns}$ ;  $R_t = 5\text{ k}\Omega$ ;  $C_t = 15\text{ pF}$ 

	$V_{DD}$ V	TYPICAL FORMULA FOR P ( $\mu\text{W}$ )	
Dynamic power	5	$4000 f_i + \sum (f_o C_L) \times V_{DD}^2$	where $f_i$ = input freq. (MHz) $f_o$ = output freq. (MHz) $C_L$ = load capacitance (pF) $\sum (f_o C_L)$ = sum of outputs $V_{DD}$ = supply voltage (V)
dissipation per	10	$20\,000 f_i + \sum (f_o C_L) \times V_{DD}^2$	
package (P)	15	$59\,000 f_i + \sum (f_o C_L) \times V_{DD}^2$	

**AC CHARACTERISTICS** $V_{SS} = 0\text{ V}$ ;  $T_{amb} = 25\text{ °C}$ ;  $C_L = 50\text{ pF}$ ; input transition times  $\leq 20\text{ ns}$ ; see also waveforms Fig.5.

	$V_{DD}$ V	SYMBOL	MIN.	TYP.	MAX.	
Recovery time for $\bar{C}_D$	5	$t_{RCD}$	0	-75	ns	
	10		0	-30	ns	
	15		0	-25	ns	
Minimum $\bar{I}_0$ pulse width; LOW	5	$t_{WI0L}$	50	25	ns	
	10		30	15	ns	
	15		20	10	ns	
Minimum $I_1$ pulse width; HIGH	5	$t_{WI1H}$	50	25	ns	
	10		30	15	ns	
	15		20	10	ns	
Minimum $\bar{C}_D$ pulse width; LOW	5	$t_{WCDL}$	60	30	ns	
	10		35	15	ns	
	15		25	10	ns	
Set-up time $\bar{C}_D \rightarrow \bar{I}_0$ or $I_1$	5	$t_{su}$	0	-105	ns	to avoid change in output
	10		0	-40	ns	
	15		0	-25	ns	
Output O pulse width; HIGH	5	$t_{WOH}$	-	235	ns	note 1
	10		-	155	ns	
	15		-	140	ns	
Output O pulse width; HIGH	5	$t_{WOH}$	-	5,45	$\mu\text{s}$	note 2
	10		-	4,95	$\mu\text{s}$	
	15		-	4,85	$\mu\text{s}$	
Change in output O pulse width over temperature	5	$\Delta t_{WO}$	-	$\pm 3$	%	note 3
	10		-	$\pm 2$	%	
	15		-	$\pm 2$	%	
Change in output O pulse width over $V_{DD}$	5	$\Delta t_{WO}$	-	$\pm 2$	%	$V_{DD} \pm 5\%$
	10		-	$\pm 1$	%	
	15		-	$\pm 1$	%	

## Dual monostable multivibrator

HEF4528B  
MSI

	V <sub>DD</sub> V	SYMBOL	MIN.	TYP.	MAX.	
External timing resistor	5	R <sub>t</sub>	5	–	2000	kΩ
	10		5	–	2000	kΩ
	15		5	–	2000	kΩ
External timing capacitor	5	C <sub>t</sub>	no limits			
	10		no limits			
	15		no limits			

**Notes**

- R<sub>t</sub> = 5 kΩ; C<sub>t</sub> = 15 pF; for other R<sub>t</sub>, C<sub>t</sub> combinations and C<sub>t</sub> < 0,01 μF see graph Fig.4.
- R<sub>t</sub> = 10 kΩ; C<sub>t</sub> = 1000 pF; for other R<sub>t</sub>, C<sub>t</sub> combinations and C<sub>t</sub> > 0,01 μF use formula  $t_{WO} = K \cdot R_t \cdot C_t$ .  
 where: t<sub>WO</sub> = output pulse width (s)  
 R<sub>t</sub> = external timing resistor (Ω)  
 C<sub>t</sub> = external timing capacitor (F)  
 K = 0,42 for V<sub>DD</sub> = 5 V  
 K = 0,32 for V<sub>DD</sub> = 10 V  
 K = 0,30 for V<sub>DD</sub> = 15 V
- T<sub>amb</sub> = –40 to +85 °C; Δt<sub>WO</sub> is referenced to t<sub>WO</sub> at T<sub>amb</sub> = 25 °C.

Dual monostable multivibrator

HEF4528B  
MSI

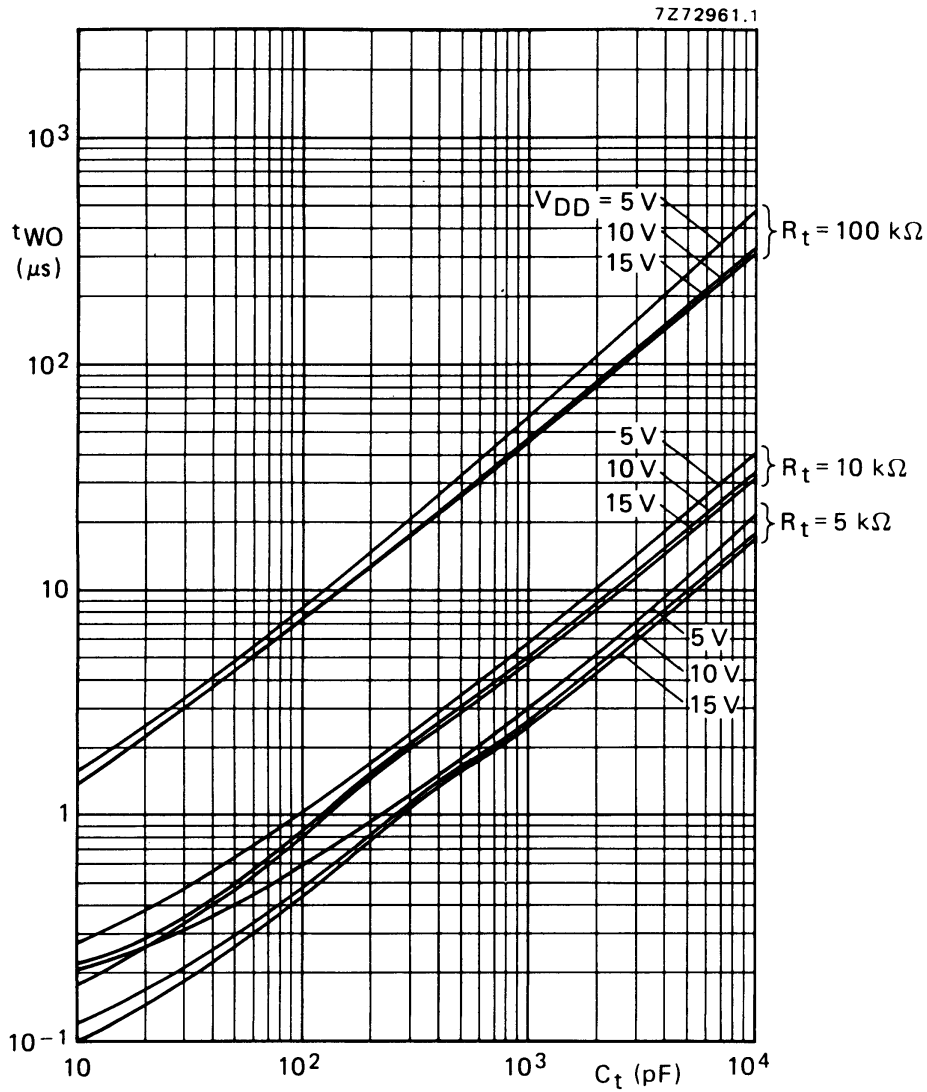

Fig.4 Output pulse width ( $t_{WO}$ ) as a function of external timing capacitor ( $C_t$ ).

Dual monostable multivibrator

HEF4528B  
MSI

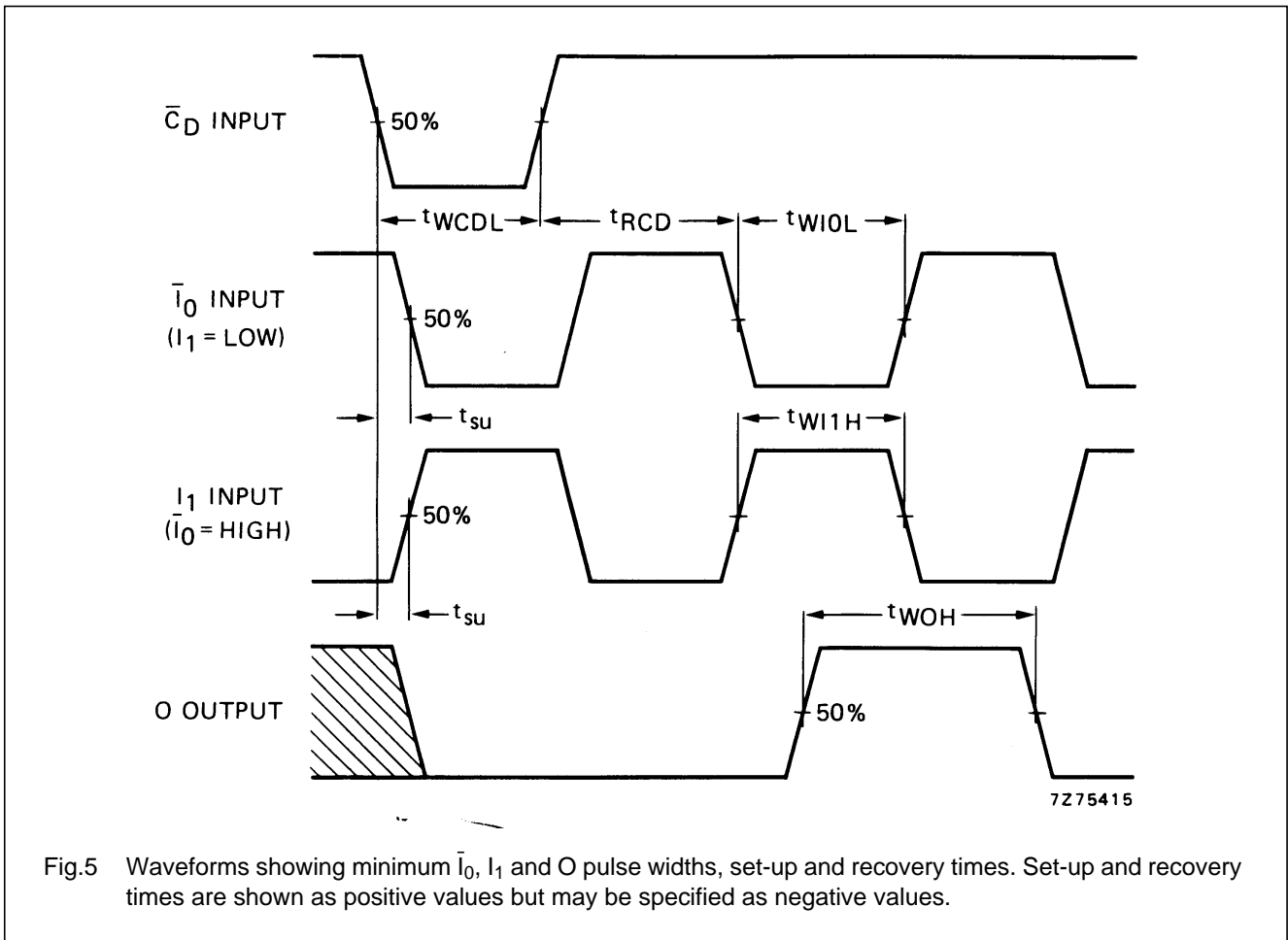

Fig.5 Waveforms showing minimum  $\bar{I}_0$ ,  $I_1$  and O pulse widths, set-up and recovery times. Set-up and recovery times are shown as positive values but may be specified as negative values.

APPLICATION INFORMATION

An example of an application for the HEF4528B is:

- Non-retriggerable monostable multivibrator

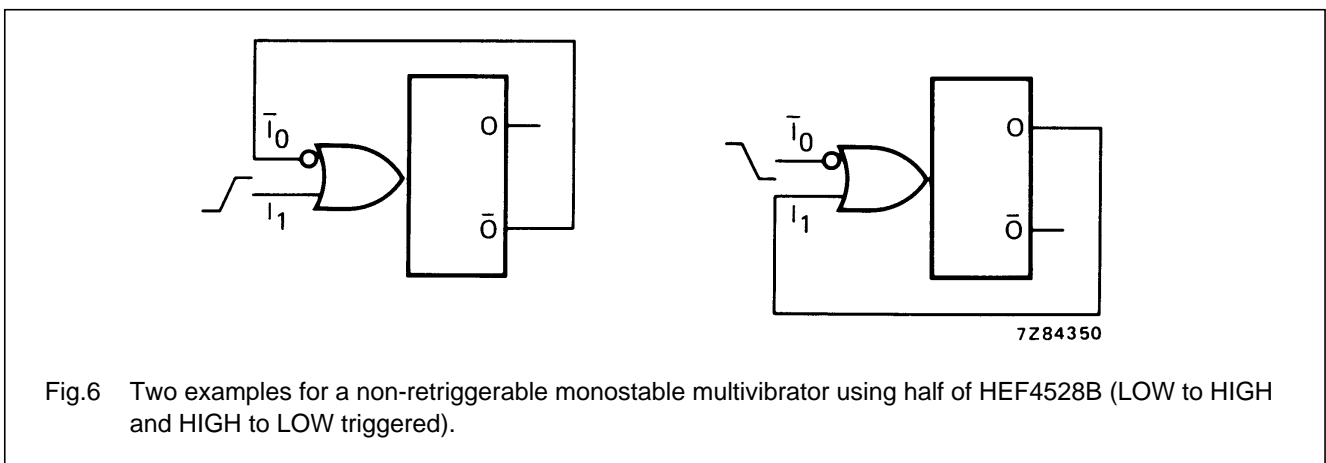

Fig.6 Two examples for a non-retriggerable monostable multivibrator using half of HEF4528B (LOW to HIGH and HIGH to LOW triggered).