

**Silicon N-Channel MOSFET Triode**

- For high-frequency stages up to 300 MHz preferably in FM applications

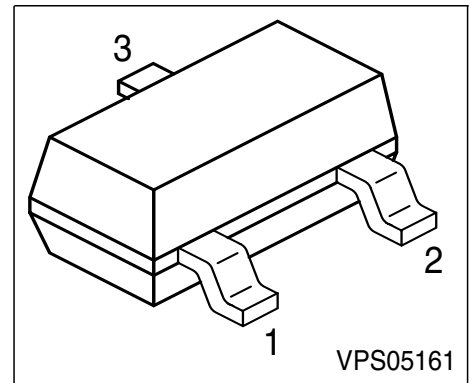

**ESD: Electrostatic discharge sensitive device, observe handling precaution!**

Type	Marking	Pin Configuration			Package
BF999	LBs	1 = G	2 = D	3 = S	SOT23

**Maximum Ratings**

Parameter	Symbol	Value	Unit
Drain-source voltage	$V_{DS}$	20	V
Drain current	$I_D$	30	mA
Gate-source peak current	$\pm I_{GSM}$	10	mA
Total power dissipation, $T_S \leq 76 \text{ }^\circ\text{C}$	$P_{tot}$	200	mW
Storage temperature	$T_{stg}$	-55 ... 150	°C
Channel temperature	$T_{ch}$	150	

**Thermal Resistance**

Channel - soldering point <sup>1)</sup>	$R_{thchs}$	$\leq 370$	K/W
---	-------------	------------	-----

<sup>1</sup>For calculation of  $R_{thJA}$  please refer to Application Note Thermal Resistance

**Electrical Characteristics** at  $T_A = 25\text{ }^\circ\text{C}$ , unless otherwise specified.

Parameter	Symbol	Values			Unit
		min.	typ.	max.	
<b>DC characteristics</b>					
Drain-source breakdown voltage $I_D = 10\text{ }\mu\text{A}$ , $-V_{GS} = 4\text{ V}$	$V_{(BR)DS}$	20	-	-	V
Gate-source breakdown voltage $\pm I_{GS} = 10\text{ mA}$ , $V_{DS} = 0$	$\pm V_{(BR)GSS}$	6.5	-	12	
Gate-source leakage current $\pm V_{GS} = 5\text{ V}$ , $V_{DS} = 0$	$\pm I_{GSS}$	-	-	50	nA
Drain current $V_{DS} = 10\text{ V}$ , $V_{GS} = 0$	$I_{DSS}$	5	-	18	mA
Gate-source pinch-off voltage $V_{DS} = 10\text{ V}$ , $I_D = 20\text{ }\mu\text{A}$	$-V_{GS(p)}$	-	-	2.5	V
<b>AC characteristics</b>					
Forward tranconductance $V_{DS} = 10\text{ V}$ , $I_D = 10\text{ mA}$	$g_{fs}$	14	16	-	mS
Gate input capacitance $V_{DS} = 10\text{ V}$ , $I_D = 10\text{ mA}$ , $f = 1\text{ MHz}$	$C_{gss}$	-	2.5	-	pF
Reverse tranfer capacitance $V_{DS} = 10\text{ V}$ , $I_D = 10\text{ mA}$ , $f = 1\text{ MHz}$	$C_{dg}$	-	25	-	fF
Output capacitance $V_{DS} = 10\text{ V}$ , $I_D = 10\text{ mA}$ , $f = 1\text{ MHz}$	$C_{dss}$	-	1	-	pF
Power gain $V_{DS} = 10\text{ V}$ , $I_D = 10\text{ mA}$ , $f = 200\text{ MHz}$	$G_p$	-	25	-	dB
Noise figure $V_{DS} = 10\text{ V}$ , $I_D = 10\text{ mA}$ , $f = 200\text{ MHz}$	$F$	-	1	-	

Total power dissipation  $P_{tot} = f(T_S)$

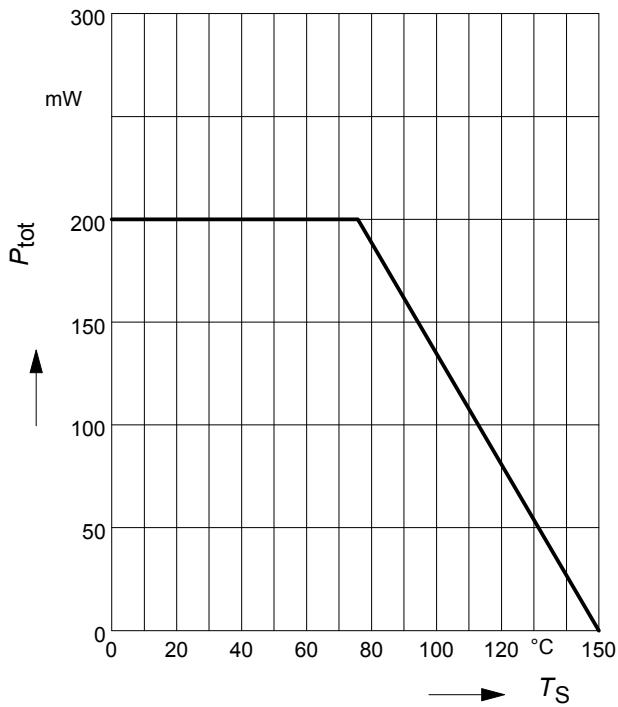

Output characteristics  $I_D = f(V_{DS})$

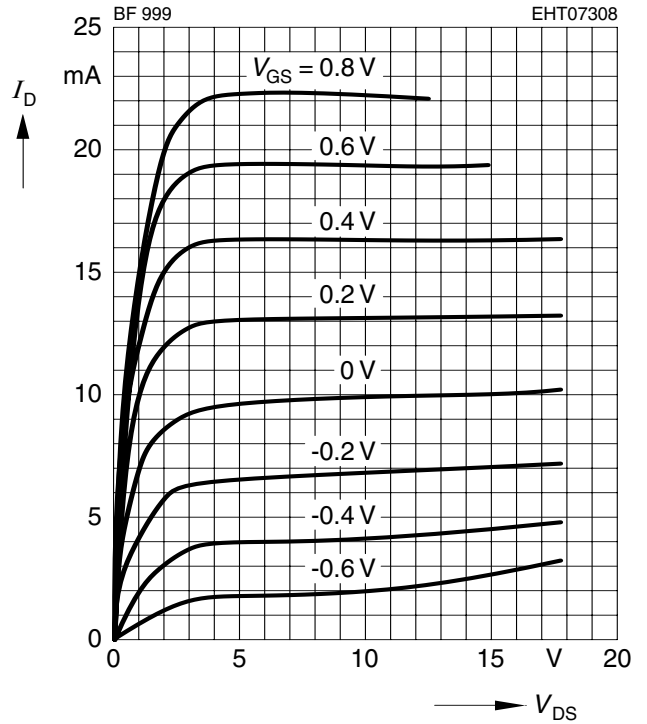

Gate transconductance  $g_{fs} = f(V_{GS})$

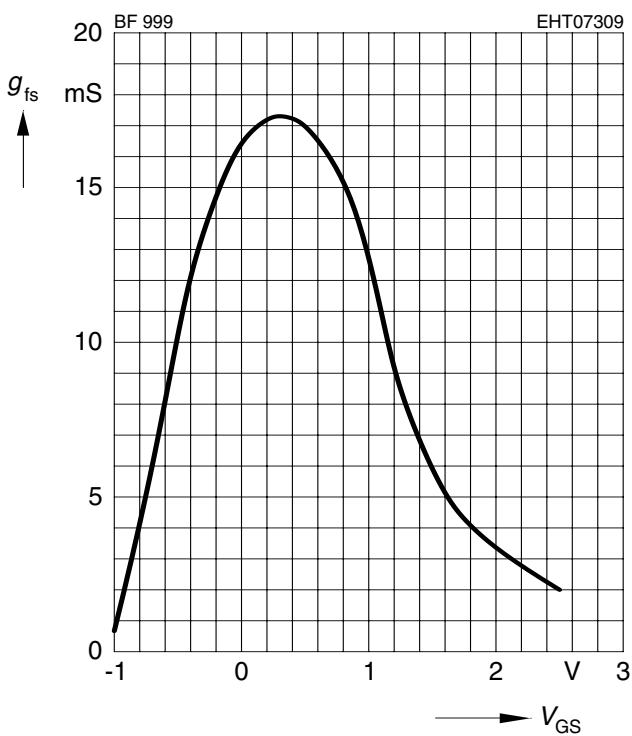

Drain current  $I_D = f(V_{GS})$

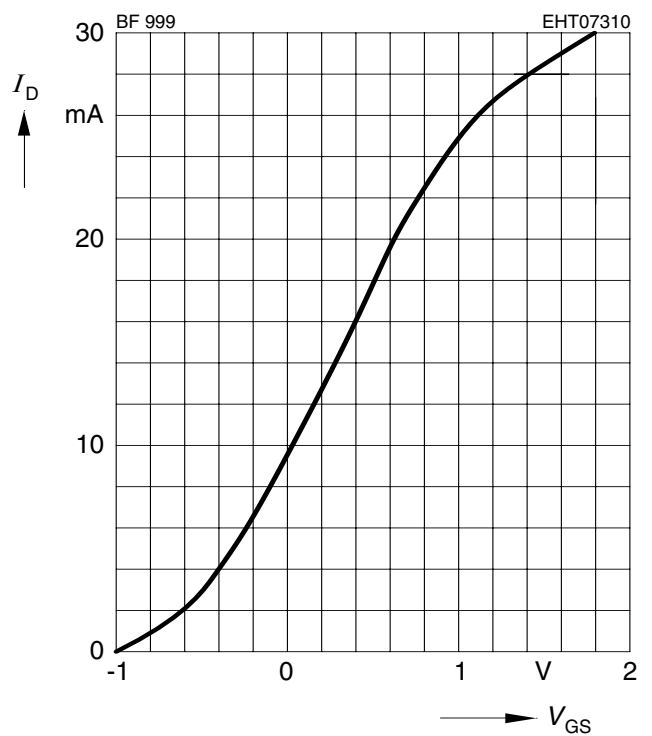

Gate input capacitance  $C_{gss} = f(V_{GS})$

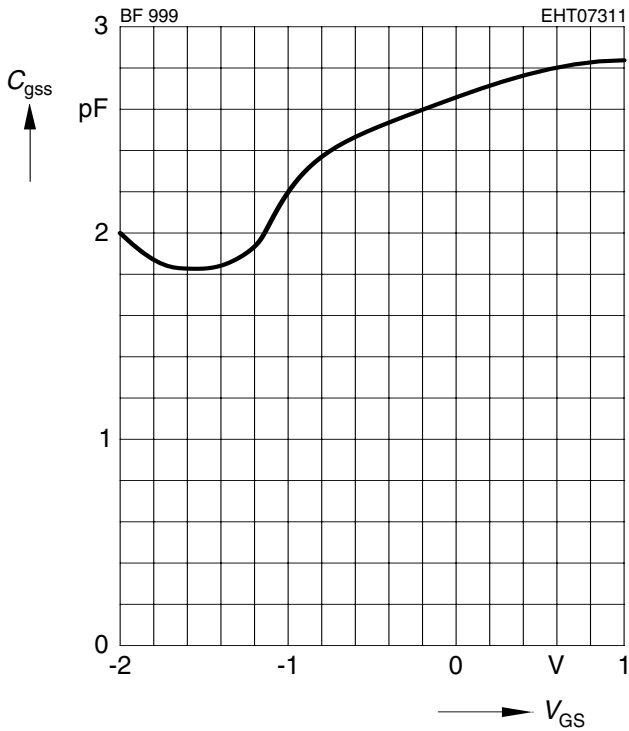

Output capacitance  $C_{dss} = f(V_{DS})$

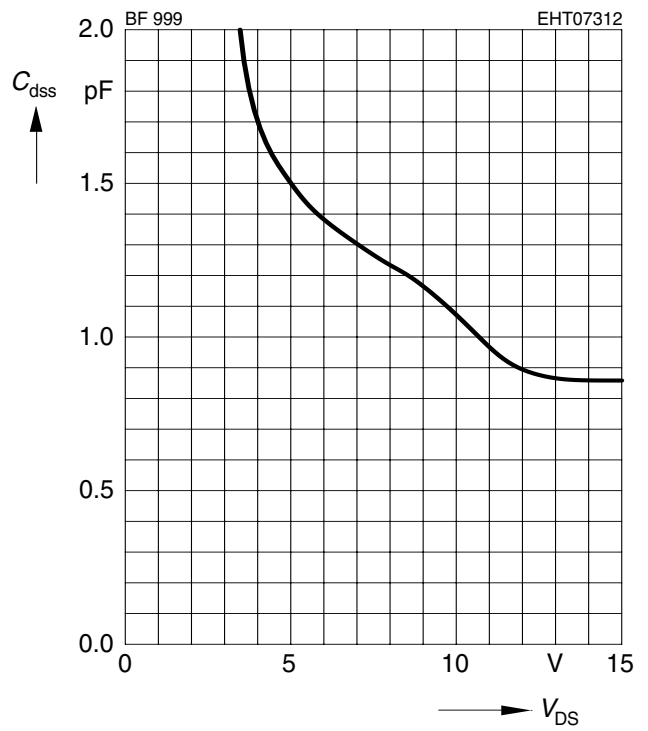

Reverse transfer capacitance

$C_{dg} = f(V_{DS})$

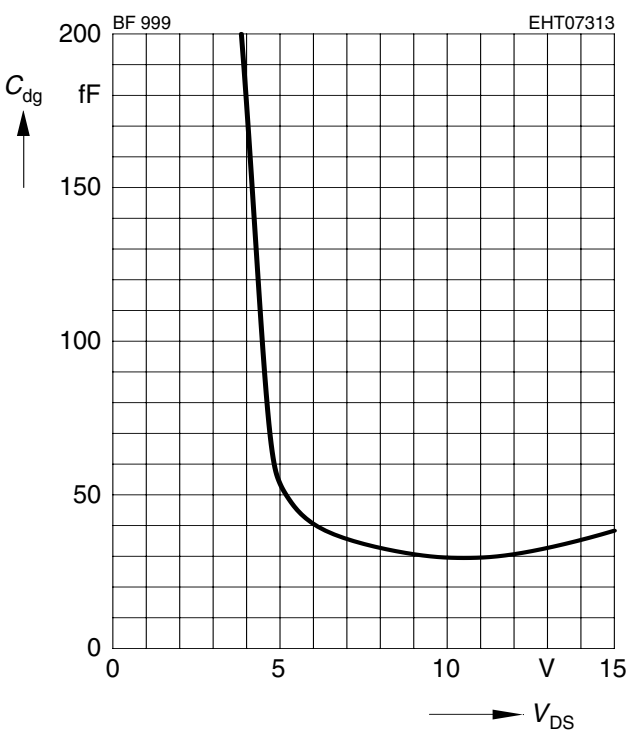

Gate input admittance  $y_{11s}$

(common-source)

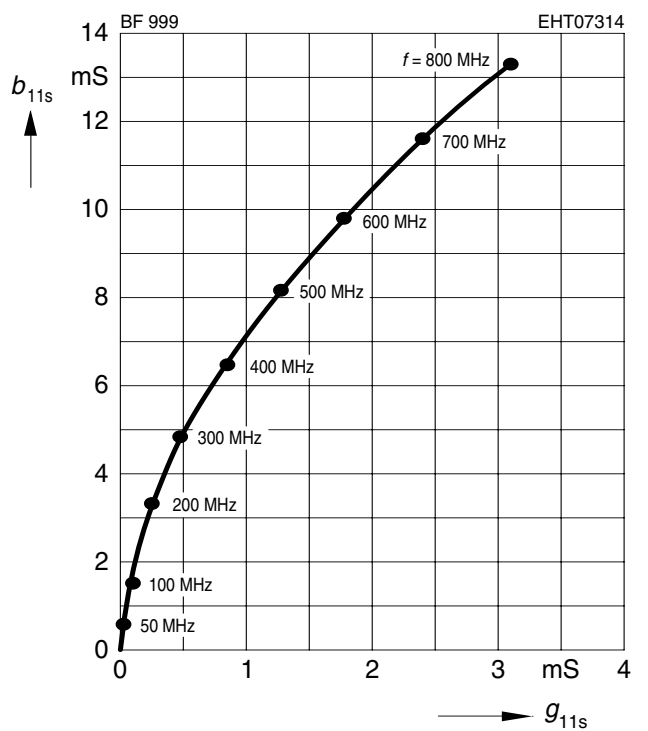

**Gate forward transfer admittance  $y_{21s}$**   
(common-source)

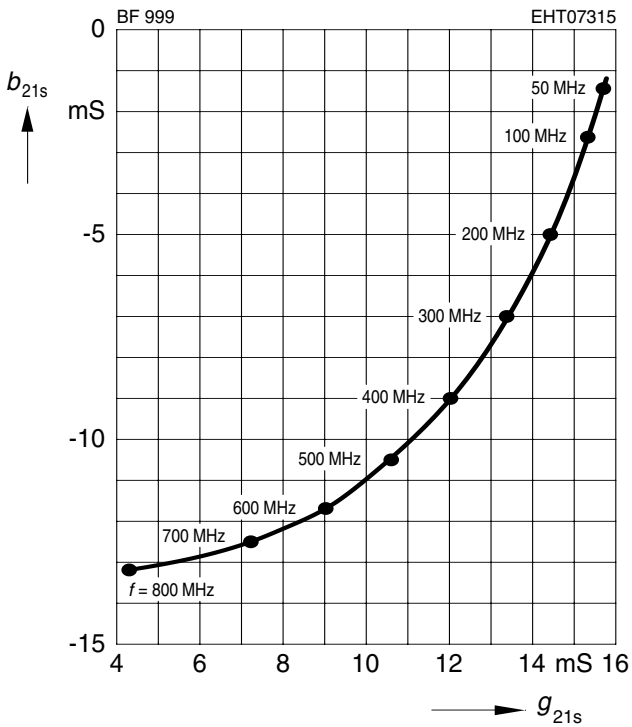

**Output admittance  $y_{22s}$**   
(common-source)

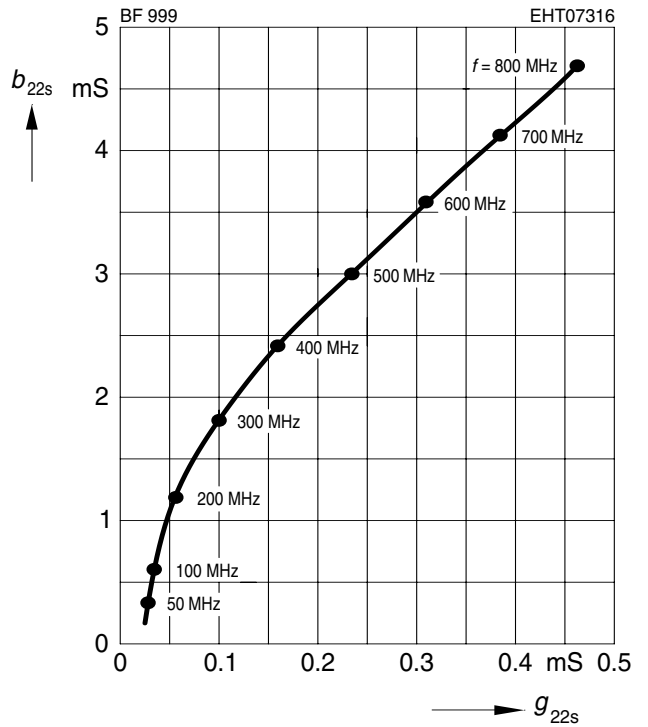

**Test circuit for power gain and noise figure**  
 $f = 200$  MHz

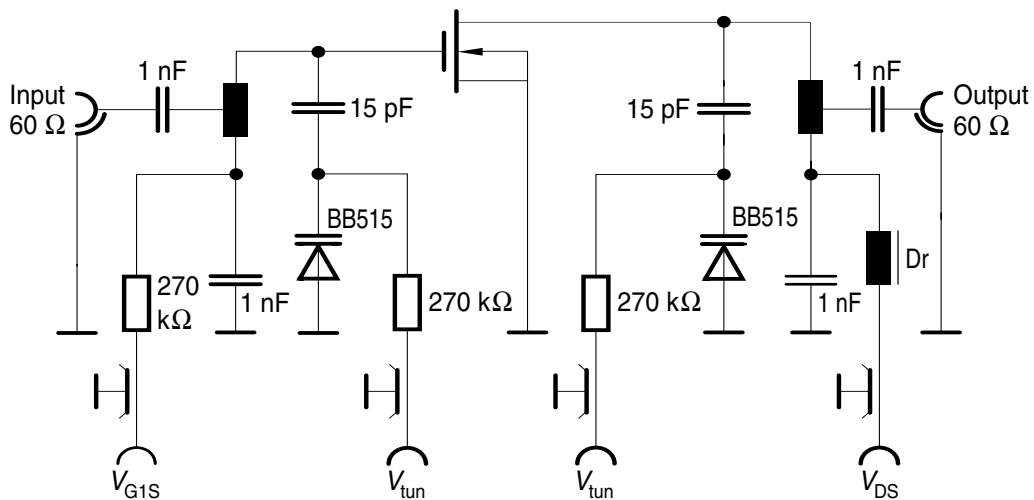

EHM07024