

# DATA SHEET

**BFM520**

Dual NPN wideband transistor

Product specification  
Supersedes data of 1995 Sep 04  
File under Discrete Semiconductors, SC14

1996 Oct 08

# Dual NPN wideband transistor

# BFM520

### FEATURES

- Small size
- Temperature and  $h_{FE}$  matched
- Low noise and high gain
- High gain at low current and low capacitance at low voltage
- Gold metallization ensures excellent reliability.

### APPLICATIONS

- Oscillator and buffer amplifiers
- Balanced amplifiers
- LNA/mixers.

### DESCRIPTION

Dual transistor with two silicon NPN RF dies in a surface mount 6-pin SOT363 (S-mini) package. The transistor is primarily intended for wideband applications in the GHz-range in the RF front end of analog and digital cellular phones, cordless phones, radar detectors, pagers and satellite TV-tuners.

### PINNING - SOT363A

PIN	SYMBOL	DESCRIPTION
1	b <sub>1</sub>	base 1
2	e <sub>1</sub>	emitter 1
3	c <sub>2</sub>	collector 2
4	b <sub>2</sub>	base 2
5	e <sub>2</sub>	emitter 2
6	c <sub>1</sub>	collector 1

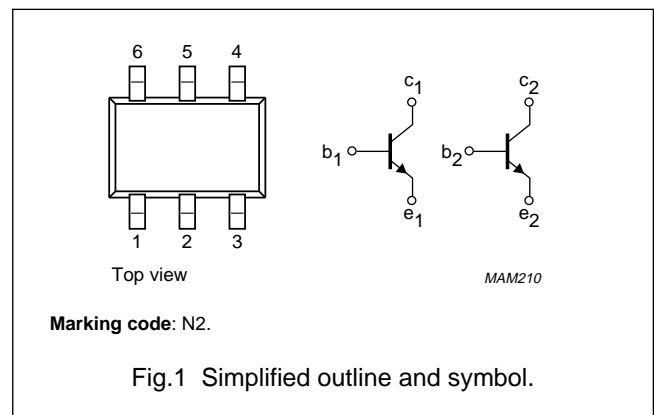

### QUICK REFERENCE DATA

SYMBOL	PARAMETER	CONDITIONS	MIN.	TYP.	MAX.	UNIT
<b>Any single transistor</b>						
C <sub>re</sub>	feedback capacitance	I <sub>e</sub> = 0; V <sub>CB</sub> = 3 V; f = 1 MHz	–	0.4	–	pF
f <sub>T</sub>	transition frequency	I <sub>C</sub> = 20 mA; V <sub>CE</sub> = 3 V; f = 900 MHz	–	9	–	GHz
S <sub>21</sub>   <sup>2</sup>	insertion power gain	I <sub>C</sub> = 20 mA; V <sub>CE</sub> = 3 V; f = 900 MHz; T <sub>amb</sub> = 25 °C	13	14.5	–	dB
G <sub>UM</sub>	maximum unilateral power gain	I <sub>C</sub> = 20 mA; V <sub>CE</sub> = 3 V; f = 900 MHz; T <sub>amb</sub> = 25 °C	–	15	–	dB
F	noise figure	I <sub>C</sub> = 5 mA; V <sub>CE</sub> = 3 V; f = 900 MHz; Γ <sub>S</sub> = Γ <sub>opt</sub>	–	1.2	1.6	dB
R <sub>th j-s</sub>	thermal resistance from junction to soldering point	single loaded	–	–	230	K/W
		double loaded	–	–	115	K/W

## Dual NPN wideband transistor

BFM520

**LIMITING VALUES**

In accordance with the Absolute Maximum System (IEC 134).

SYMBOL	PARAMETER	CONDITIONS	MIN.	MAX.	UNIT
<b>Any single transistor</b>					
V <sub>CBO</sub>	collector-base voltage	open emitter	–	20	V
V <sub>CEO</sub>	collector-emitter voltage	open base	–	8	V
V <sub>EBO</sub>	emitter-base voltage	open collector	–	2.5	V
I <sub>C</sub>	DC collector current		–	70	mA
P <sub>tot</sub>	total power dissipation	up to T <sub>s</sub> = 118 °C; note 1	–	1	W
T <sub>stg</sub>	storage temperature		–65	+175	°C
T <sub>j</sub>	junction temperature		–	175	°C

**THERMAL CHARACTERISTICS**

SYMBOL	PARAMETER	CONDITIONS	VALUE	UNIT
R <sub>th j-s</sub>	thermal resistance from junction to soldering point; note 1	single loaded	230	K/W
		double loaded	115	K/W

**Note to the Limiting values and Thermal characteristics**1. T<sub>s</sub> is the temperature at the soldering point of the collector pin.

## Dual NPN wideband transistor

## BFM520

## CHARACTERISTICS

$T_j = 25\text{ °C}$  unless otherwise specified.

SYMBOL	PARAMETER	CONDITIONS	MIN.	TYP.	MAX.	UNIT
<b>DC characteristics of any single transistor</b>						
$V_{(BR)CBO}$	collector-base breakdown voltage	$I_C = 2.5\ \mu\text{A}; I_E = 0$	20	–	–	V
$V_{(BR)CEO}$	collector-emitter breakdown voltage	$I_C = 10\ \mu\text{A}; I_B = 0$	8	–	–	V
$V_{(BR)EBO}$	emitter-base breakdown voltage	$I_E = 2.5\ \mu\text{A}; I_C = 0$	2.5	–	–	V
$I_{CBO}$	collector-base leakage current	$V_{CB} = 6\ \text{V}; I_E = 0$	–	–	50	nA
$h_{FE}$	DC current gain	$I_C = 20\ \text{mA}; V_{CE} = 6\ \text{V}$	60	120	250	
<b>DC characteristics of the dual transistor</b>						
$\Delta h_{FE}$	ratio of highest and lowest DC current gain	$I_{C1} = I_{C2} = 20\ \text{mA}; V_{CE1} = V_{CE2} = 6\ \text{V}$	1	1.2	–	
$\Delta V_{BEO}$	difference between highest and lowest base-emitter voltage (offset voltage)	$I_{E1} = I_{E2} = 30\ \text{mA}; T_{amb} = 25\text{ °C}$	0	1	–	mV
<b>AC characteristics of any single transistor</b>						
$f_T$	transition frequency	$I_C = 20\ \text{mA}; V_{CE} = 3\ \text{V}; f = 1\ \text{GHz}$	–	9	–	GHz
$C_c$	collector capacitance	$I_E = i_e = 0; V_{CB} = 3\ \text{V}; f = 1\ \text{MHz}$	–	0.5	–	pF
$C_{re}$	feedback capacitance	$I_C = 0; V_{CB} = 3\ \text{V}; f = 1\ \text{MHz}$	–	0.4	–	pF
$G_{UM}$	maximum unilateral power gain; note 1	$I_C = 20\ \text{mA}; V_{CE} = 3\ \text{V}; T_{amb} = 25\text{ °C}; f = 900\ \text{MHz}$	–	15	–	dB
		$I_C = 20\ \text{mA}; V_{CE} = 3\ \text{V}; T_{amb} = 25\text{ °C}; f = 2\ \text{GHz}$	–	9	–	dB
$ s_{21} ^2$	insertion power gain	$I_C = 20\ \text{mA}; V_{CE} = 3\ \text{V}; f = 900\ \text{MHz}; T_{amb} = 25\text{ °C}$	13	14.5	–	dB
F	noise figure	$I_C = 5\ \text{mA}; V_{CE} = 3\ \text{V}; f = 900\ \text{MHz}; \Gamma_S = \Gamma_{opt}$	–	1.2	1.6	dB
		$I_C = 20\ \text{mA}; V_{CE} = 3\ \text{V}; f = 900\ \text{MHz}; \Gamma_S = \Gamma_{opt}$	–	1.7	2.1	dB
		$I_C = 5\ \text{mA}; V_{CE} = 3\ \text{V}; f = 2\ \text{GHz}; \Gamma_S = \Gamma_{opt}$	–	1.9	–	dB

## Note

1.  $G_{UM}$  is the maximum unilateral power gain, assuming  $s_{12}$  is zero.  $G_{UM} = 10 \log \frac{|s_{21}|^2}{(1 - |s_{11}|^2)(1 - |s_{22}|^2)}$  dB

Dual NPN wideband transistor

BFM520

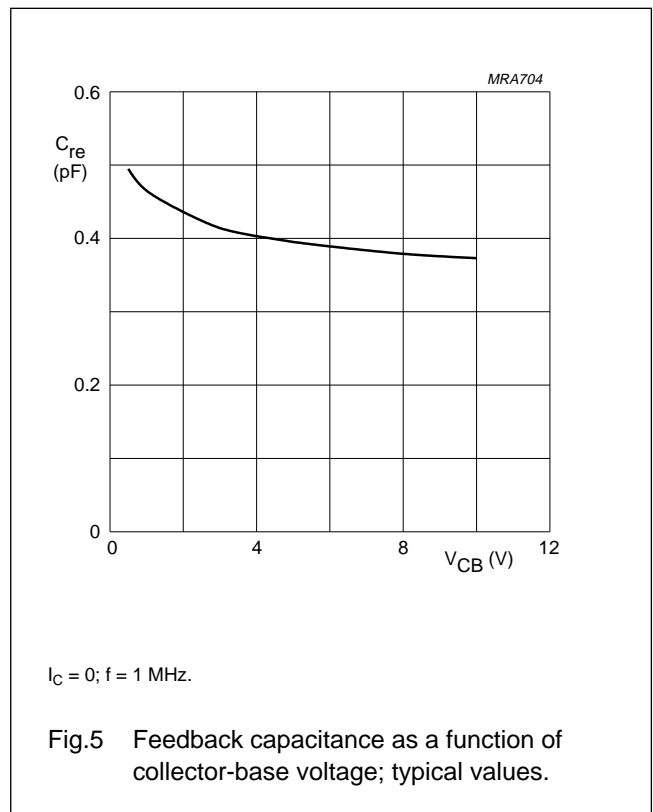
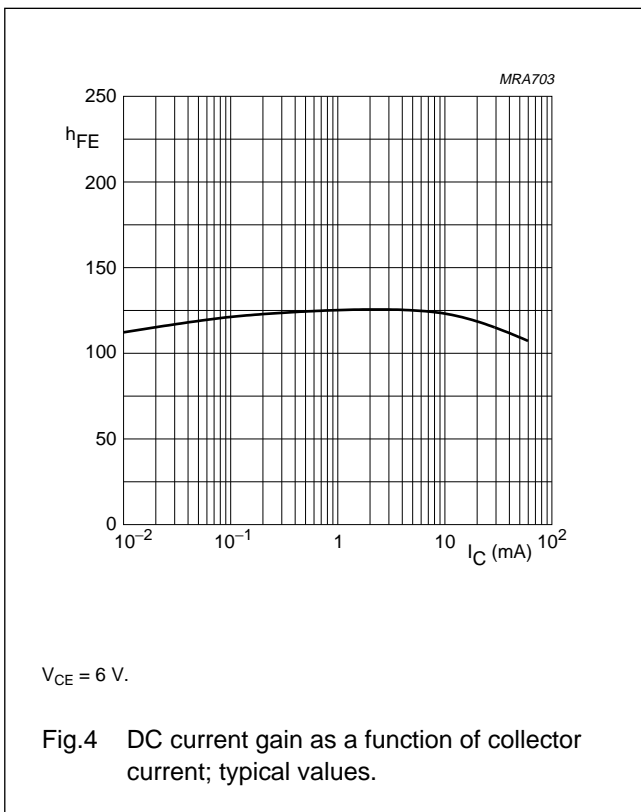
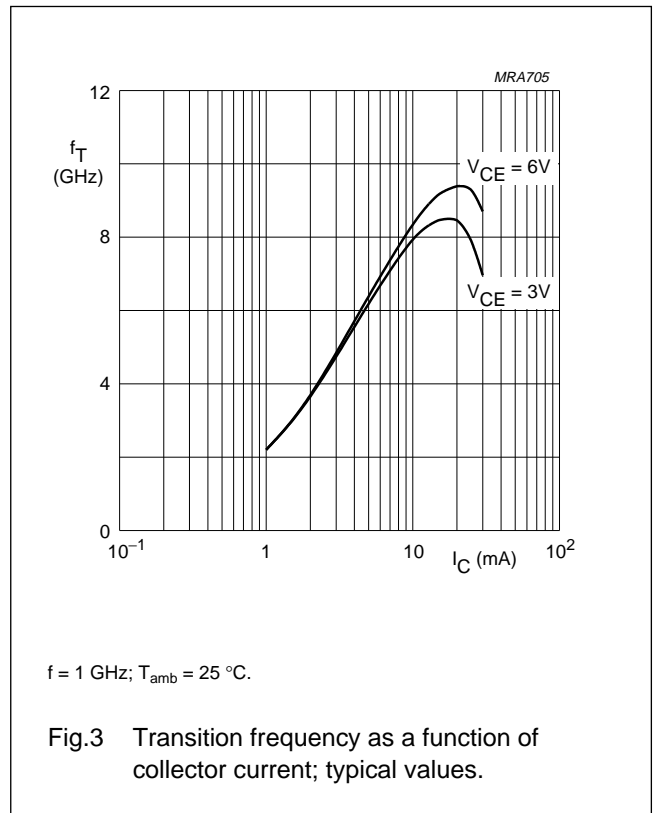
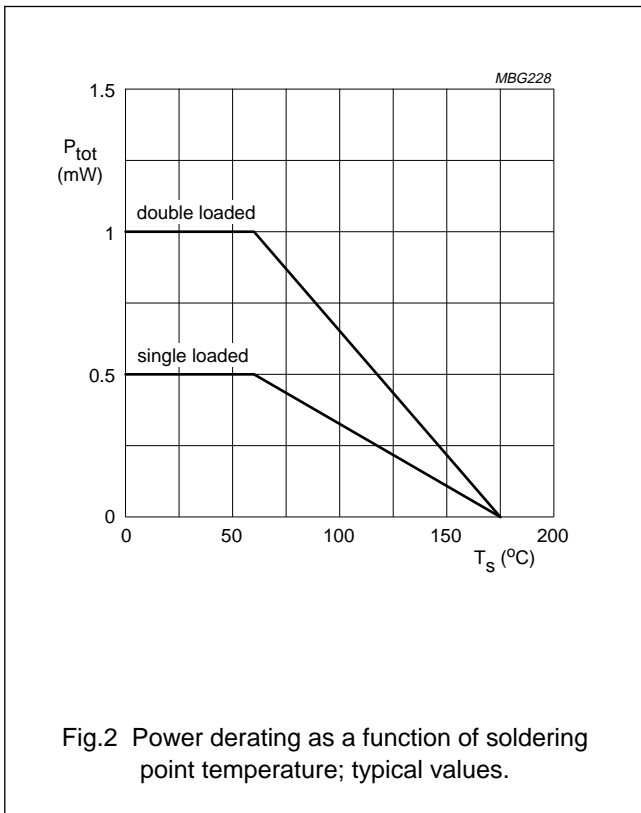

Dual NPN wideband transistor

BFM520

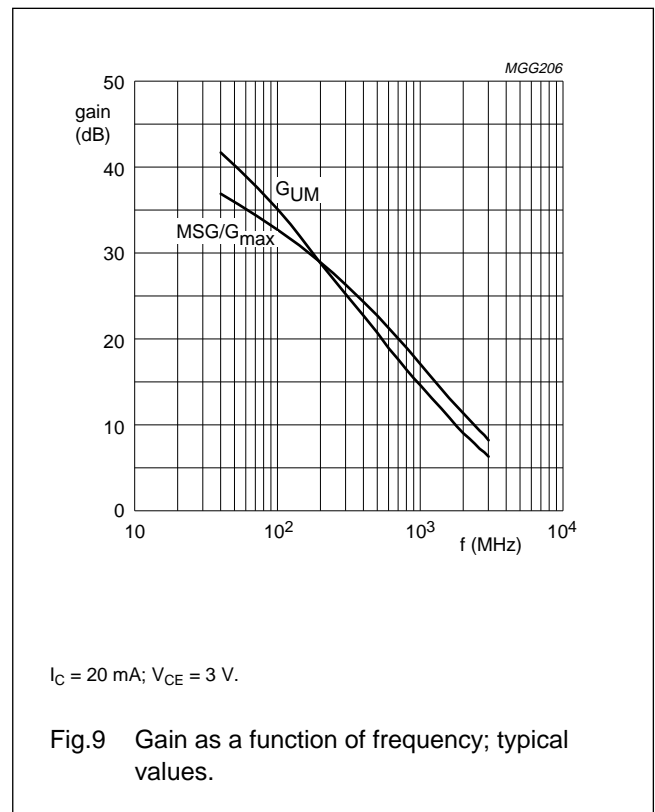
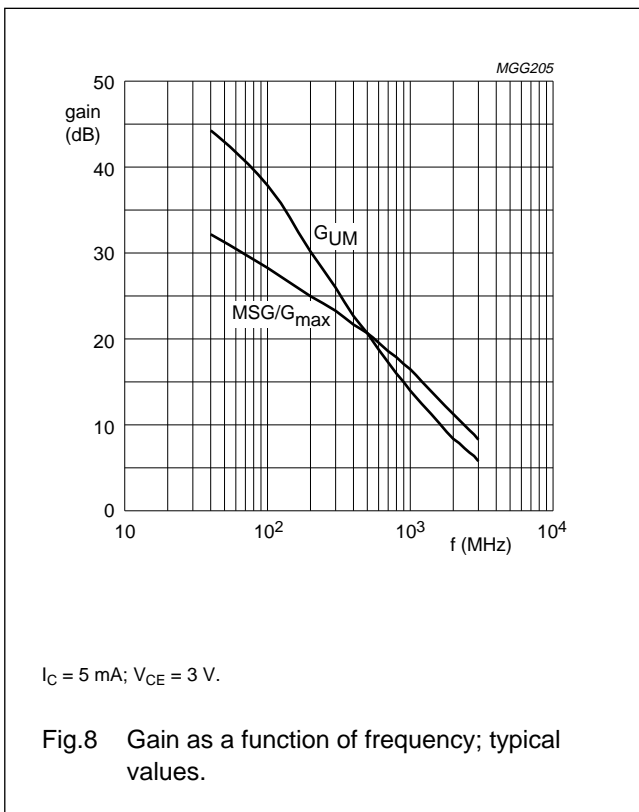
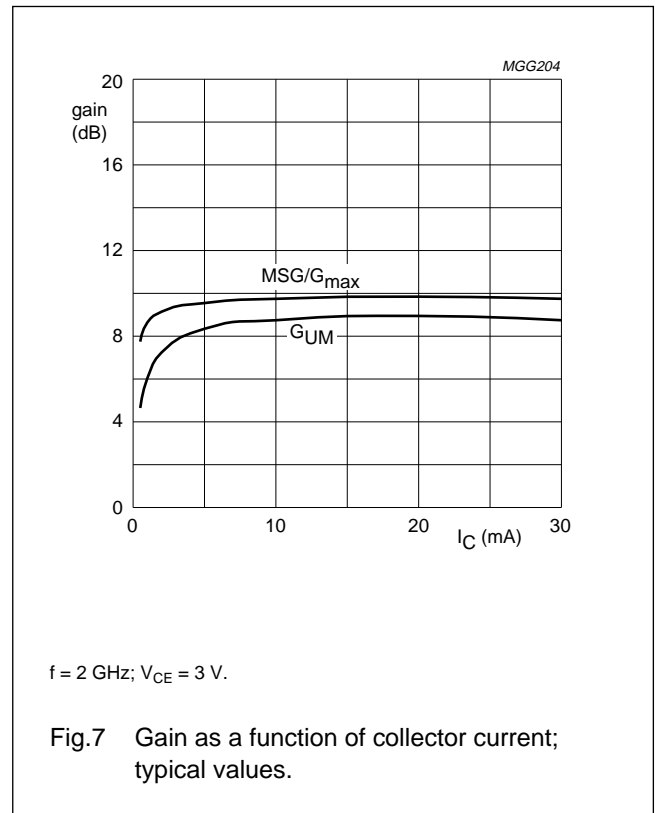
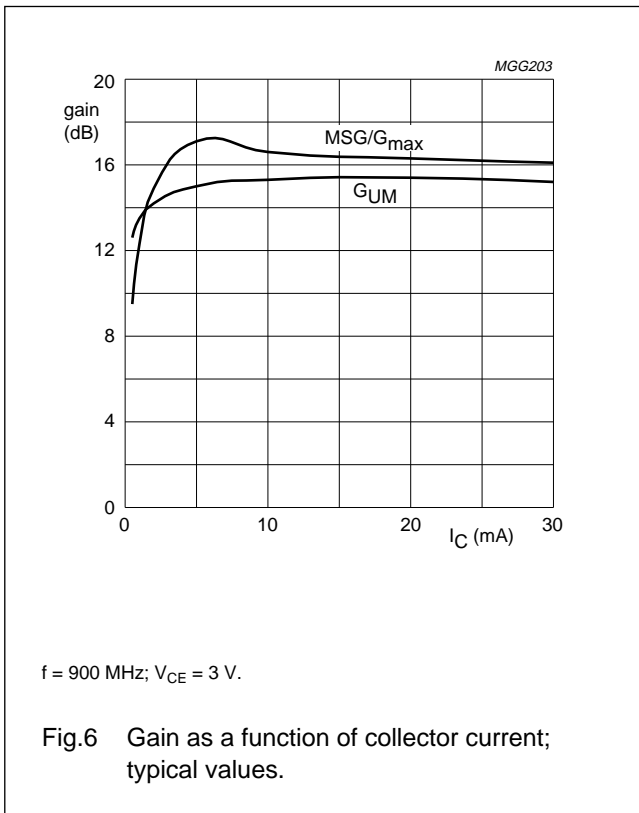

Dual NPN wideband transistor

BFM520

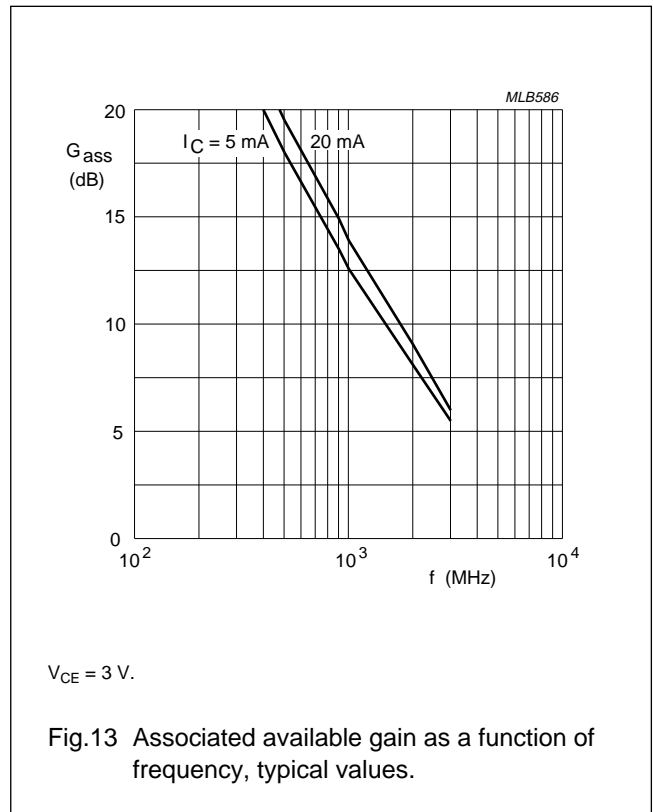
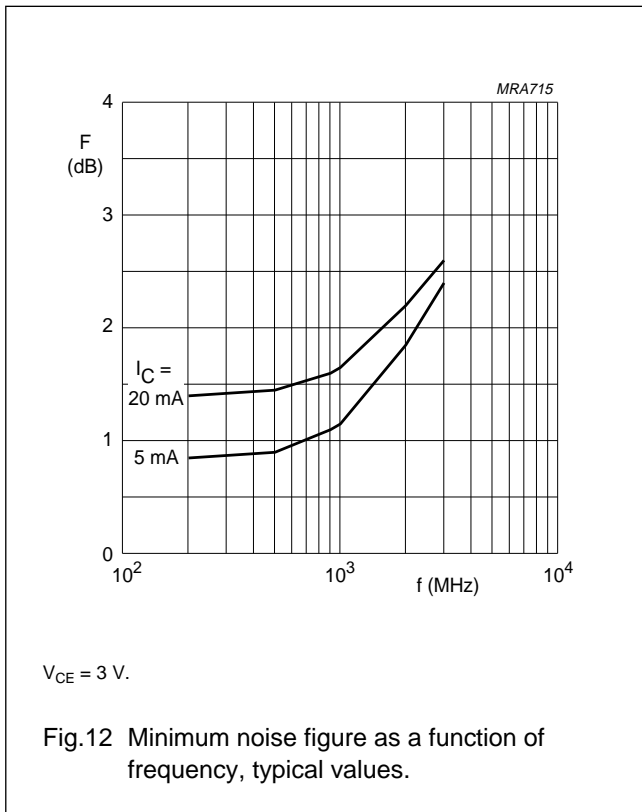
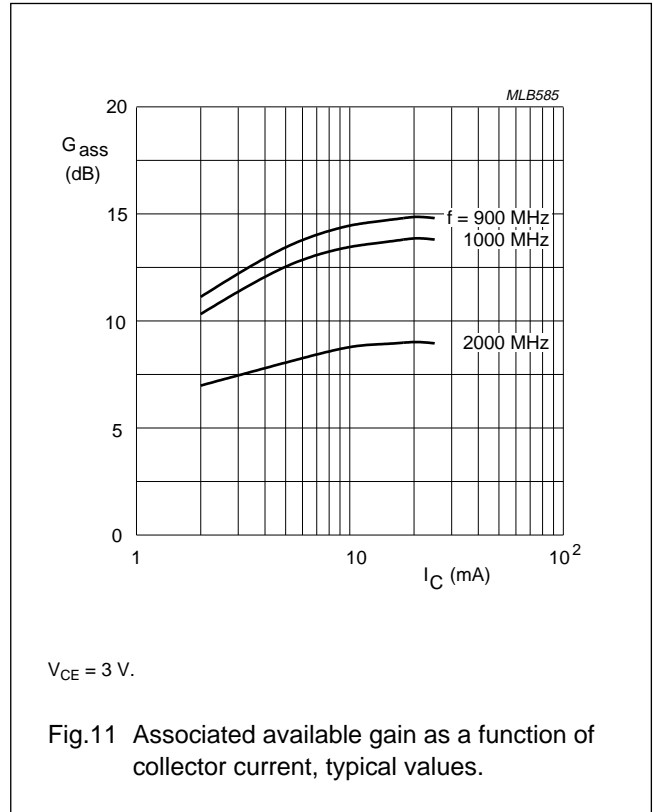
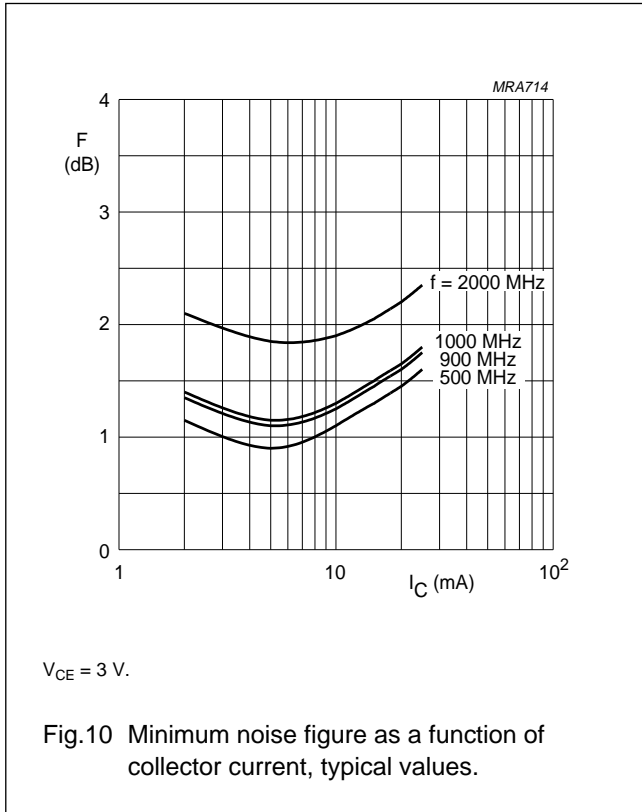

# Dual NPN wideband transistor

# BFM520

## APPLICATION INFORMATION

### SPICE parameters for any single BFM520 die

SEQUENCE No.	PARAMETER	VALUE	UNIT
1	IS	1.016	fA
2	BF	220.1	–
3	NF	1.000	–
4	VAF	48.06	V
5	IKF	510.0	mA
6	ISE	283.0	fA
7	NE	2.035	–
8	BR	100.7	–
9	NR	0.988	–
10	VAR	1.692	V
11	IKR	2.352	mA
12	ISC	24.48	aA
13	NC	1.022	–
14	RB	10.00	Ω
15	IRB	1.000	μA
16	RBM	10.00	Ω
17	RE	0.775	Ω
18	RC	2.210	Ω
19 <sup>(1)</sup>	XTB	0.000	–
20 <sup>(1)</sup>	EG	1.110	eV
21 <sup>(1)</sup>	XTI	3.000	–
22	CJE	1.245	pF
23	VJE	600.0	mV
24	MJE	0.258	–
25	TF	8.616	ps
26	XTF	6.788	–
27	VTF	1.414	V
28	ITF	110.3	mA
29	PTF	45.01	deg
30	CJC	447.6	fF
31	VJC	189.2	mV
32	MJC	0.071	–
33	XCJC	0.130	–
34	TR	543.7	ps
35 <sup>(1)</sup>	CJS	0.000	F
36 <sup>(1)</sup>	VJS	750.0	mV
37 <sup>(1)</sup>	MJS	0.000	–
38	FC	0.780	–

### Note

1. These parameters have not been extracted, the default values are shown.

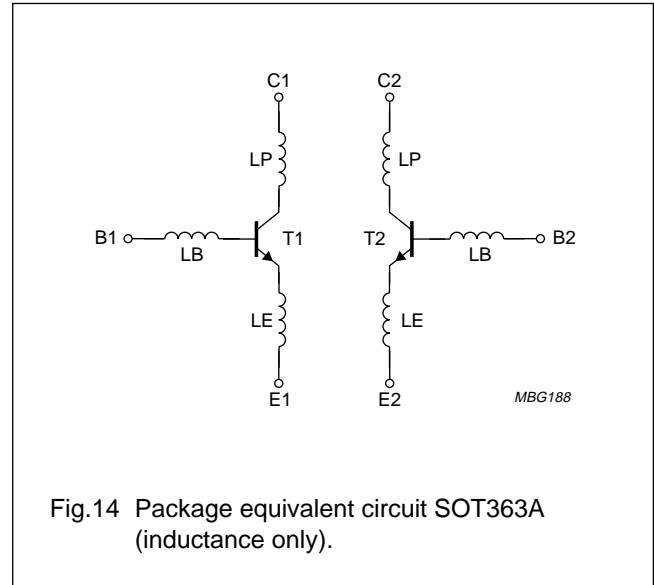

Fig.14 Package equivalent circuit SOT363A (inductance only).

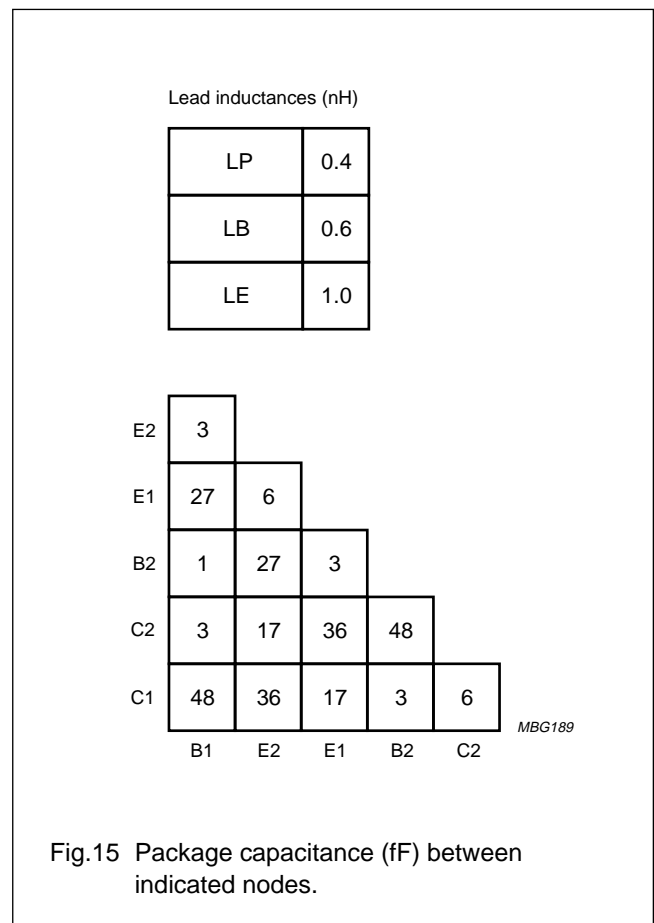

Fig.15 Package capacitance (fF) between indicated nodes.



Dual NPN wideband transistor

BFM520

PACKAGE OUTLINE

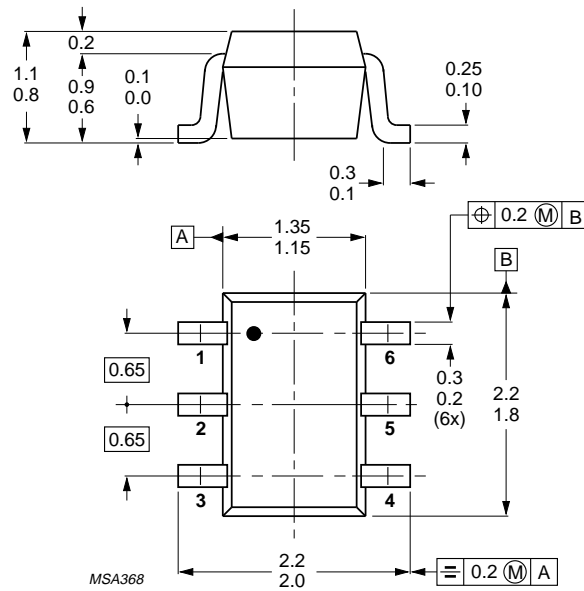

Dimensions in mm.

Fig.16 SOT363.

## Dual NPN wideband transistor

BFM520

**DEFINITIONS**

<b>Data sheet status</b>	
Objective specification	This data sheet contains target or goal specifications for product development.
Preliminary specification	This data sheet contains preliminary data; supplementary data may be published later.
Product specification	This data sheet contains final product specifications.
Short-form specification	The data in this specification is extracted from a full data sheet with the same type number and title. For detailed information see the relevant data sheet or data handbook.
<b>Limiting values</b>	
Limiting values given are in accordance with the Absolute Maximum Rating System (IEC 134). Stress above one or more of the limiting values may cause permanent damage to the device. These are stress ratings only and operation of the device at these or at any other conditions above those given in the Characteristics sections of the specification is not implied. Exposure to limiting values for extended periods may affect device reliability.	
<b>Application information</b>	
Where application information is given, it is advisory and does not form part of the specification.	

**LIFE SUPPORT APPLICATIONS**

These products are not designed for use in life support appliances, devices, or systems where malfunction of these products can reasonably be expected to result in personal injury. Philips customers using or selling these products for use in such applications do so at their own risk and agree to fully indemnify Philips for any damages resulting from such improper use or sale.

This datasheet has been download from:

[www.datasheetcatalog.com](http://www.datasheetcatalog.com)

Datasheets for electronics components.