

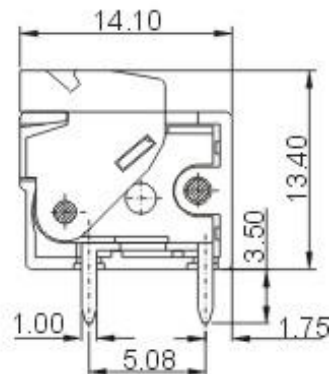

**DG142R-5.08**

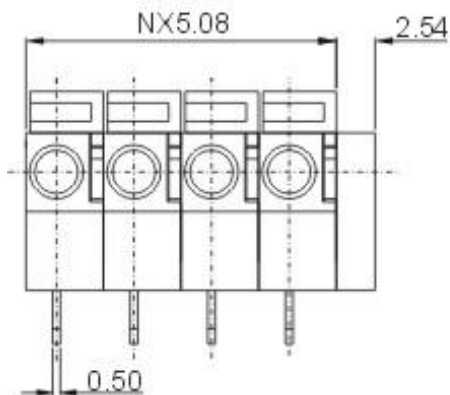
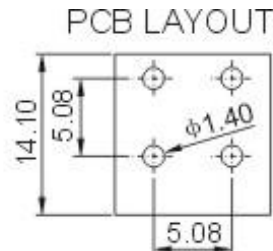
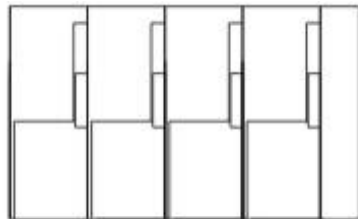

<b>Approval</b>		
<b>Electrical</b>		
<b>Standard</b>	<b>UL</b>	<b>IEC</b>
Rated voltage	300V	250V
Rated current	10A	15A
Wire range	22-16AWG	0.2-1.5mm <sup>2</sup>
Withstanding voltage	AC2000V/1Min	
<b>Mechanical</b>		
Ambient temperature	-40°C ~ +105 °C	
Strip length	10mm	
<b>Dimensions</b>		
Pitch	5.08mm (.200" )	
Poles	1P-XXP	
<b>Material</b>		
Housing	PA66,UL94V-0	
Pin header	Brass, Tin plated	
Wire guard	Stainless steel	

**HOW TO ORDER :**

-  **P** -  - 
 

X	X	X
Customer Request		



Series number

No. of pole

1	Single pitch
2	Double pitch

**Color**

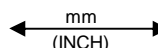
1 Grey	4 Green	7 Trans Parent
2 Blue	5 Orange	8 Yellow
3 Black	6 Red	9 White

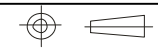
 mm (INCH)	 <b>DEGSON ELECTRONICS CO., LTD.</b>
 THROANGLE PROJECTION	<b>NAME</b> <b>DG142R-5.08</b>