





<b>APPROVAL Electrical</b>		
Standard	<b>UL</b>	<b>IEC</b>
Rated voltage	150V	130V
Rated current	6A	8A
Wire range	26-18AWG	1.0mm <sup>2</sup>
Withstanding voltage	AC1250V/1Min	
<b>Menchanical</b>		
Torque	0.1Nm(0.89Lb-In)	
Ambient temperature	-40°C~+105 °C	
Strip length	4.5mm	
<b>Dimensions</b>		
pitch	2.54mm(.100" )	
Poles	2P-20P	
<b>Material</b>		
Housing	PA66,UL94V-0	
Screws	M1.6,Steel, Cr <sup>3+</sup> Znplated	
Pin header	Brass,Tin plated	
Cage	Brass,Ni plated	



### HOW TO ORDER :

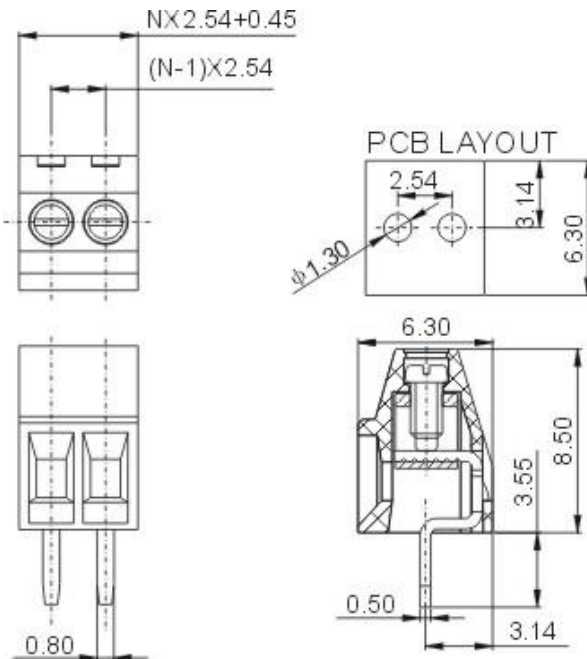
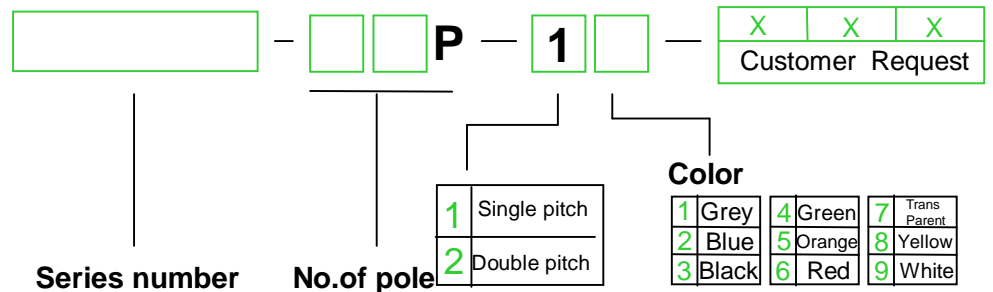
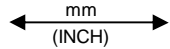

	 <b>DEGSON ELECTRONICS CO., LTD.</b>
	<b>NAME</b> <b>DG308-2.54</b>