

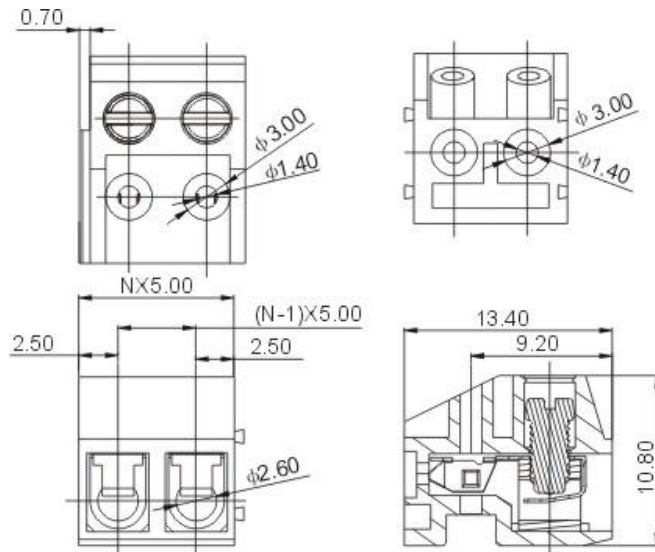





**DG332K-5.0**

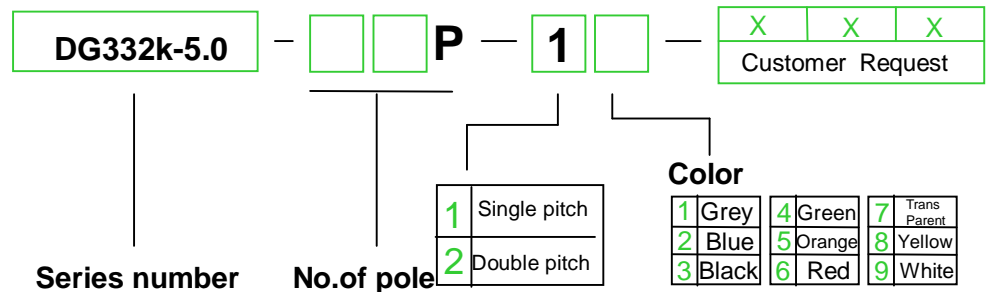

<b>APPROVAL</b>		
<b>Electrical</b>		
Standard	<b>UL</b>	<b>IEC</b>
Rated voltage	300V	250V
Rated current	10A	12A
Wire range	28-16AWG	1.5mm <sup>2</sup>
Withstanding voltage	AC2000V/1Min	
<b>Mechanical</b>		
Torque	0.4Nm(3.5Lb-In)	
Ambient temperature	-30°C ~ +120 °C	
Strip length	5-6mm	
<b>Dimensions</b>		
Pitch	5.0mm(.197")	
Poles	2P,3P-24P	
<b>Material</b>		
Housing	PBT,UL94V-0	
Screws	M2.5,steel, C <sup>2+</sup> Zn;planted	
Contact	Phosphor bronze	
Cage:	Brass Ni plated	

### HOW TO ORDER :

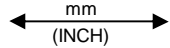

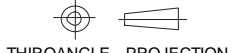
	 <b>DEGSON ELECTRONICS CO., LTD.</b>
	<b>NAME</b> <b>DG332K-5.0</b>