

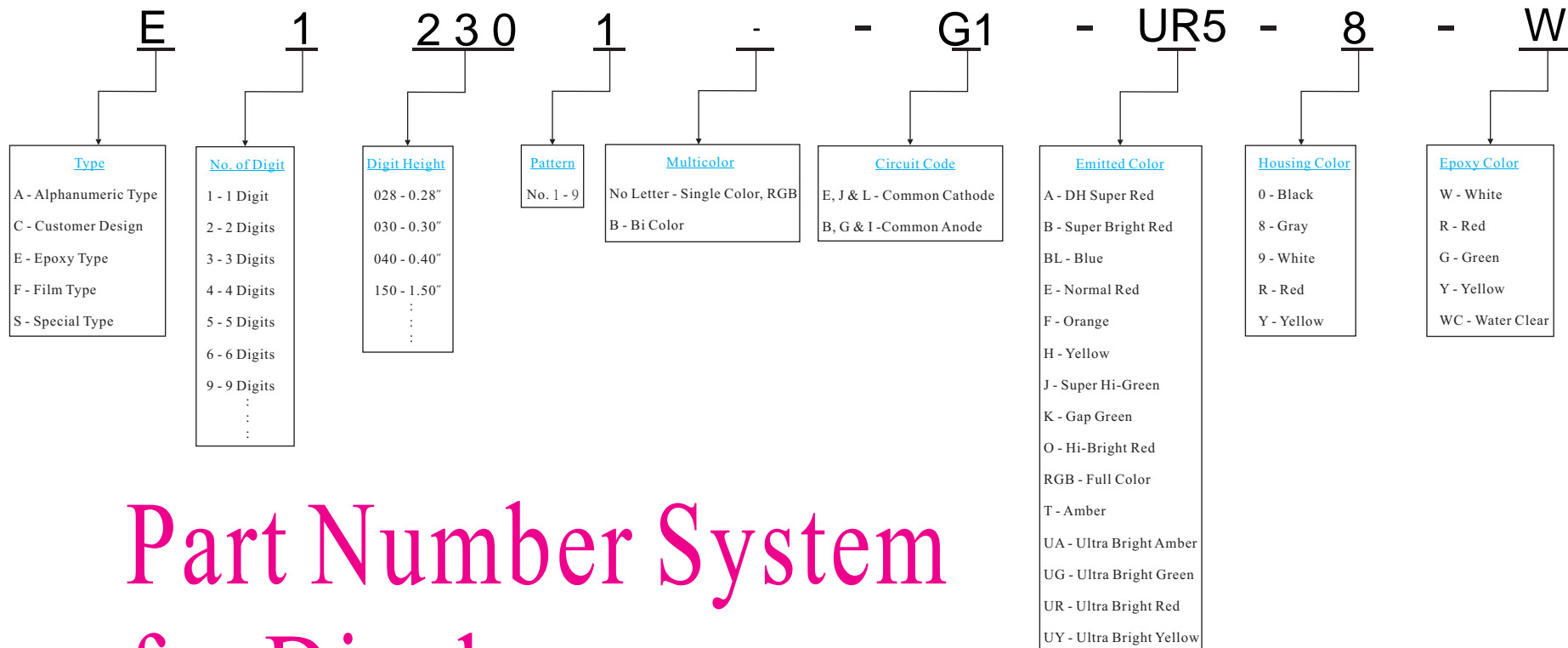

TOYO LED ELECTRONICS LIMITED

<http://www.toyo-led.com>

e-mail: sales@toyo-led.com



Part Number System for Displays



TOYO LED ELECTRONICS LIMITED

<http://www.toyo-led.com>

e-mail: sales@toyo-led.com

PACKAGE DIMENSION

E12301

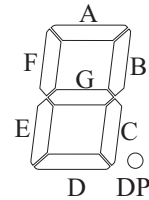
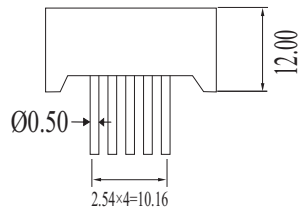
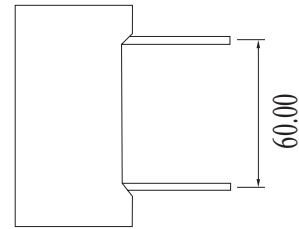
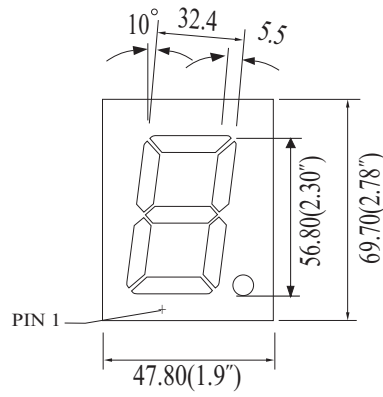

UNIT: MM(INCH) TOLERANCE: $\pm 0.25(0.01'')$

INTERNAL CIRCUIT DIAGRAM

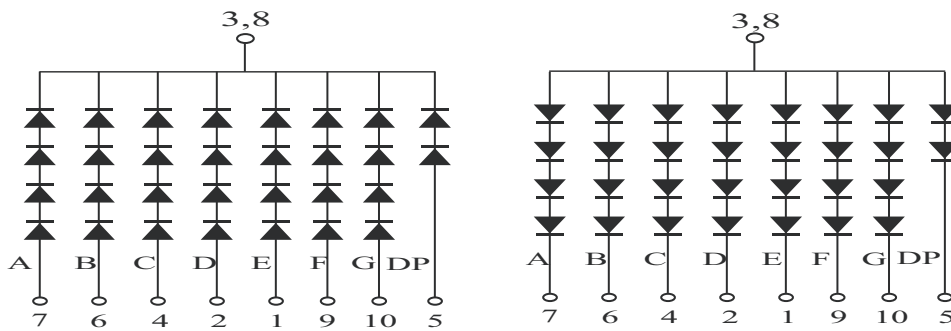

CODE J1

CODE G1



TOYO LED ELECTRONICS LIMITED

Room 1610, Hong Kong Plaza, 188 Connaught Road West, Hong Kong.

Tel: (852) 2540 7288

Fax: (852) 2517 1797

<http://www.toyo-led.com>

email: sales@toyo-led.com



CODE UR5

Chip Material: AlGaInP / GaAs Ultra Bright Red LED Chip



ABSOLUTE MAXIMUM RATINGS (Ta = 25°C)

PARAMETER	SYMBOL	MAXIMUM RATING	UNIT
Power Dissipation	P _D	72	mW
Peak Forward Current (1/10 Duty Cycle, 0.1 Ms Pulse Width)	I _{PEAK}	90	mA
DC Forward Current	I _F	30	mA
Reverse Voltage	V _R	5	V
Operating Temperature Range	T _A	-40°C to +85°C	
Storage Temperature Range	T _{STG}	-40°C to +85°C	
Solder temperature 1/16 inch below seating plane for 3 seconds at 260°C			

ELECTRICAL OPTICAL CHARACTER AND CURVES (Ta = 25°C)

PARAMETER	SYMBOL	MIN	TYP	MAX	UNIT	LOCATION	TEST CONDITION
Forward Voltage	V _F	-	2.10	2.40	V	Per Chip	I _F = 20mA
Luminous Intensity	I _v	75.0	80.0	85.0	mcd	Per Chip	I _F = 20mA
Peak Emission Wavelength	λ _p	-	645	-	nm	Per Chip	I _F = 20mA
Dominant Emission Wavelength	λ _d	626	631	636	nm	Per Chip	I _F = 20mA
Spectral Line Half-Width	Δλ _{1/2}	-	20	-	nm	Per Chip	I _F = 20mA
Capacitance	C	-	95	-	pF	Per Chip	V _F = 0V; f = 1MHz
Reverse Current	I _R	-	-	10	uA	Per Chip	V _R = 5V

Note:

- Luminous intensity tolerance is ±10%;**
- Dominant Emission Wavelength tolerance is ±5%.**



TOYO LED ELECTRONICS LIMITED

Room 1610, Hong Kong Plaza, 188 Connaught Road West, Hong Kong.

Tel: (852) 2540 7288

<http://www.toyo-led.com>

Fax: (852) 2517 1797

email: sales@toyo-led.com



CODE UR5

■ Typical Electro-Optical Characteristic Curve:

FIG. 1 Forward Current Vs. Forward Voltage

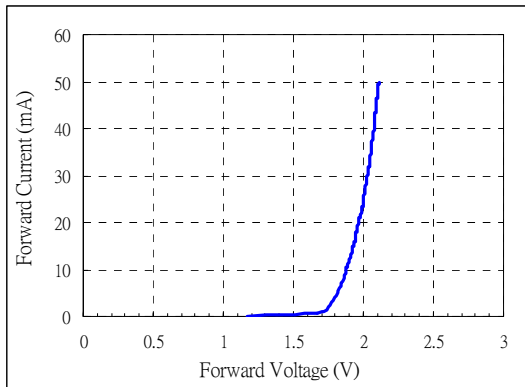

FIG. 2 Relative Intensity Vs. Forward Current

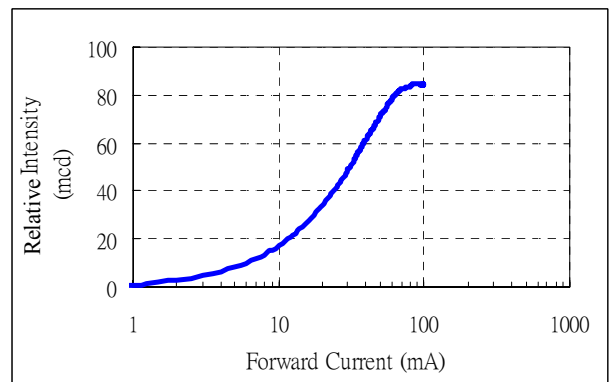

FIG. 3 Forward Voltage Vs. Temperature

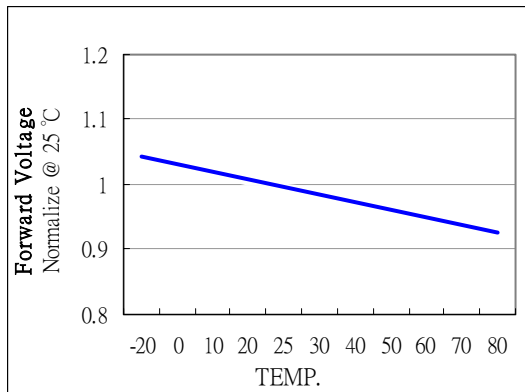

FIG. 4 Relative Intensity Vs. Temperature

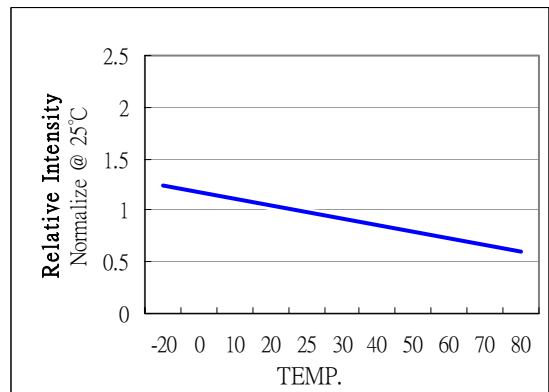

FIG. 5 Relative Intensity Vs. Wavelength

