

PIN Connection TO-220

Switching Regulator Application

Features

- High voltage: $BV_{DSS}=800V$
- Low gate charge: $Q_g=40nC$ (Typ.)
- Low drain-source On resistance: $R_{DS(on)}=1.6\Omega$ (Max.)
- 100% avalanche tested
- RoHS compliant device and available in halogen free device

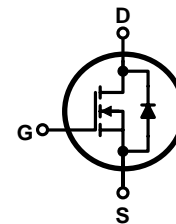
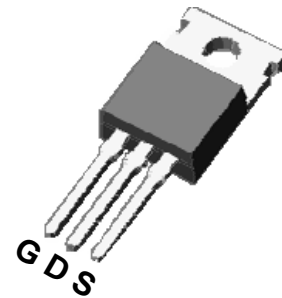

Marking Diagram



Y = Year
 A = Assembly Location
 WW = Work Week
 FIR8N80P = Specific Device Code

Absolute maximum ratings ($T_c=25^\circ C$ unless otherwise noted)

Characteristic	Symbol	Rating	Unit	
Drain-source voltage	V_{DSS}	800	V	
Gate-source voltage	V_{GSS}	± 30	V	
Drain current (DC) *	I_D	$T_c=25^\circ C$	7	A
		$T_c=100^\circ C$	4.4	A
Drain current (Pulsed) *	I_{DM}	28	A	
Avalanche current ^(Note 2)	I_{AS}	7	A	
Single pulsed avalanche energy ^(Note 2)	E_{AS}	522	mJ	
Repetitive avalanche current ^(Note 1)	I_{AR}	7	A	
Repetitive avalanche energy ^(Note 1)	E_{AR}	4.5	mJ	
Power dissipation	P_D	45	W	
Junction temperature	T_J	150	$^\circ C$	
Storage temperature range	T_{stg}	-55~150	$^\circ C$	

Thermal Characteristics

Characteristic	Symbol	Rating	Unit
Thermal resistance, junction to case	$R_{th(j-c)}$	Max. 2.77	°C/W
Thermal resistance, junction to ambient	$R_{th(j-a)}$	Max. 62.5	

Electrical Characteristics ($T_C=25^\circ\text{C}$ unless otherwise noted)

Characteristic	Symbol	Test Condition	Min.	Typ.	Max.	Unit
Drain-source breakdown voltage	BV_{DSS}	$I_D=250\mu\text{A}$, $V_{GS}=0$	800	-	-	V
Gate threshold voltage	$V_{GS(th)}$	$I_D=250\mu\text{A}$, $V_{DS}=V_{GS}$	3	-	5	V
Drain-source cut-off current	I_{DSS}	$V_{DS}=800\text{V}$, $V_{GS}=0\text{V}$	-	-	1	μA
Gate leakage current	I_{GSS}	$V_{DS}=0\text{V}$, $V_{GS}=\pm 30\text{V}$	-	-	± 100	nA
Drain-source on-resistance	$R_{DS(on)}$	$V_{GS}=10\text{V}$, $I_D=3.5\text{A}$	-	1.28	1.6	Ω
Forward transfer conductance (Note 3)	g_{fs}	$V_{DS}=10\text{V}$, $I_D=3.5\text{A}$	-	5.6	-	S
Input capacitance	C_{iss}	$V_{DS}=25\text{V}$, $V_{GS}=0\text{V}$, $f=1.0\text{MHz}$	-	1650	-	pF
Output capacitance	C_{oss}		-	135	-	
Reverse transfer capacitance	C_{rss}		-	15	-	
Turn-on delay time (Note 3,4)	$t_{d(on)}$	$V_{DD}=400\text{V}$, $I_D=7\text{A}$, $R_G=25\Omega$	-	40	-	ns
Rise time (Note 3,4)	t_r		-	110	-	
Turn-off delay time (Note 3,4)	$t_{d(off)}$		-	65	-	
Fall time (Note 3,4)	t_f		-	70	-	
Total gate charge (Note 3,4)	Q_g	$V_{DS}=640\text{V}$, $V_{GS}=10\text{V}$, $I_D=7\text{A}$	-	40	-	nC
Gate-source charge (Note 3,4)	Q_{gs}		-	12	-	
Gate-drain charge (Note 3,4)	Q_{gd}		-	15	-	

Source-Drain Diode Ratings and Characteristics ($T_C=25^\circ\text{C}$ unless otherwise noted)

Characteristic	Symbol	Test Condition	Min.	Typ.	Max.	Unit
Source current (DC)	I_S	Integral reverse diode in the MOSFET	-	-	7	A
Source current (Pulsed)	I_{SM}		-	-	28	A
Forward voltage	V_{SD}	$V_{GS}=0\text{V}$, $I_S=7\text{A}$	-	-	1.4	V
Reverse recovery time (Note 3,4)	t_{rr}	$I_S=7\text{A}$, $V_{GS}=0\text{V}$ $di_f/dt=100\text{A}/\mu\text{s}$	-	560	-	ns
Reverse recovery charge (Note 3,4)	Q_{rr}		-	4	-	μC

Note:

1. Repeated rating: Pulse width limited by safe operating area
2. $L=20\text{mH}$, $I_{AS}=7\text{A}$, $V_{DD}=50\text{V}$, $R_G=25\Omega$, Starting $T_J=25^\circ\text{C}$
3. Pulse test: Pulse width $\leq 300\mu\text{s}$, Duty cycle $\leq 2\%$
4. Essentially independent of operating temperature typical characteristics

Electrical Characteristics Curves

Fig. 1 $I_D - V_{DS}$

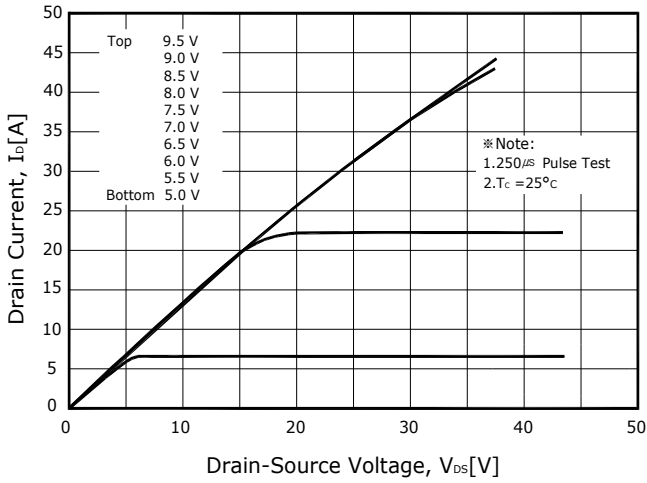

Fig. 2 $I_D - V_{GS}$

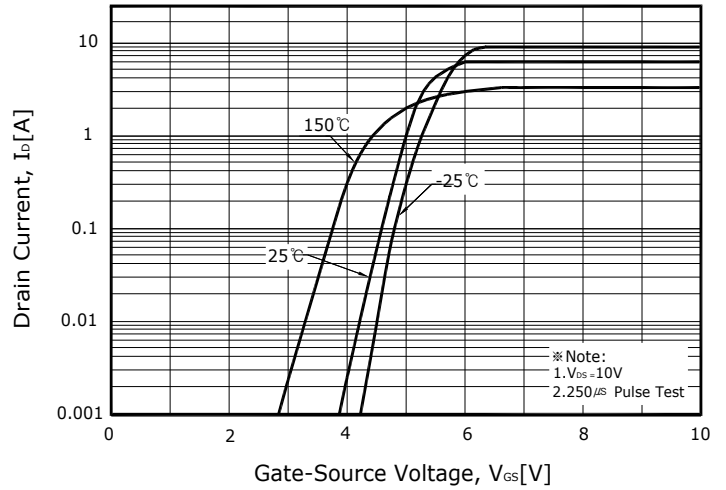

Fig. 3 $R_{DS(ON)} - I_D$

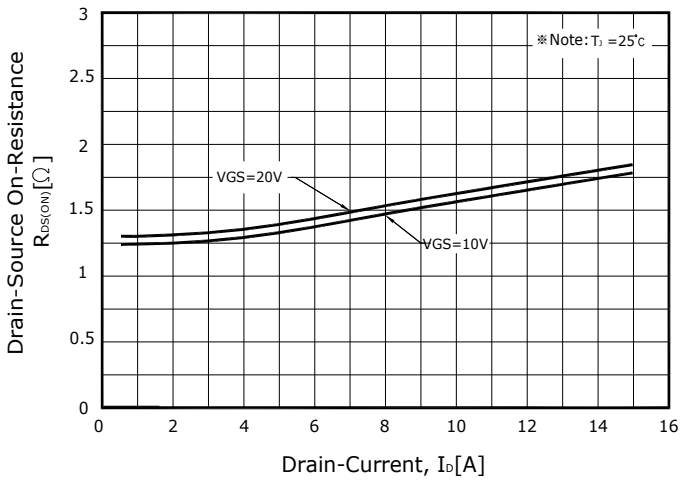

Fig. 4 $I_S - V_{SD}$

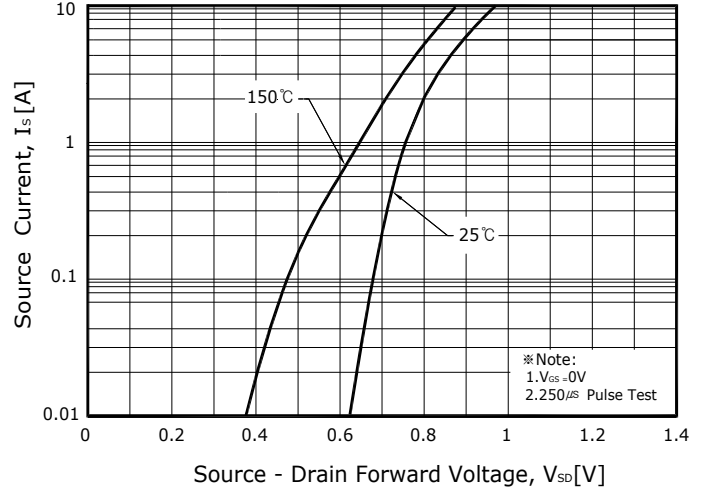

Fig. 5 Capacitance - V_{DS}

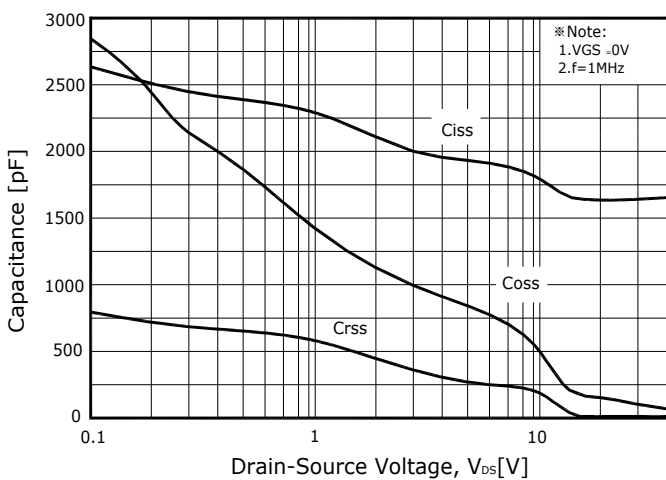

Fig. 6 $V_{GS} - Q_G$

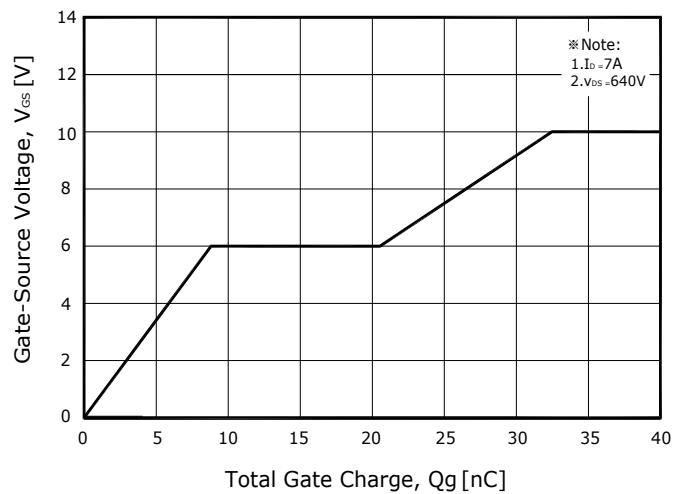

Fig. 7 $BV_{DSS} - T_J$

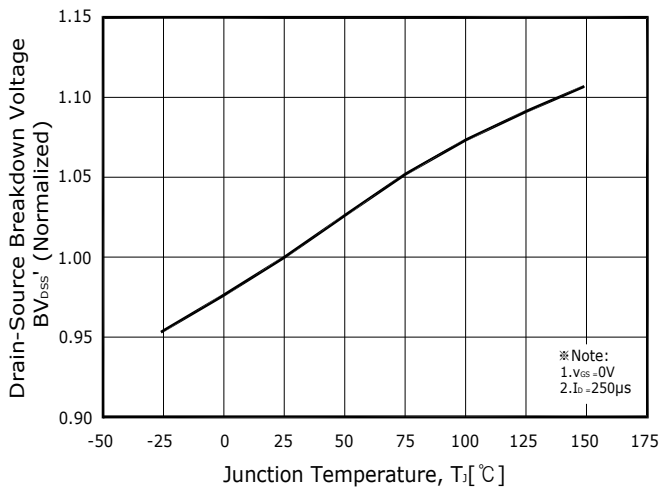

Fig. 8 $R_{DS(on)} - T_J$

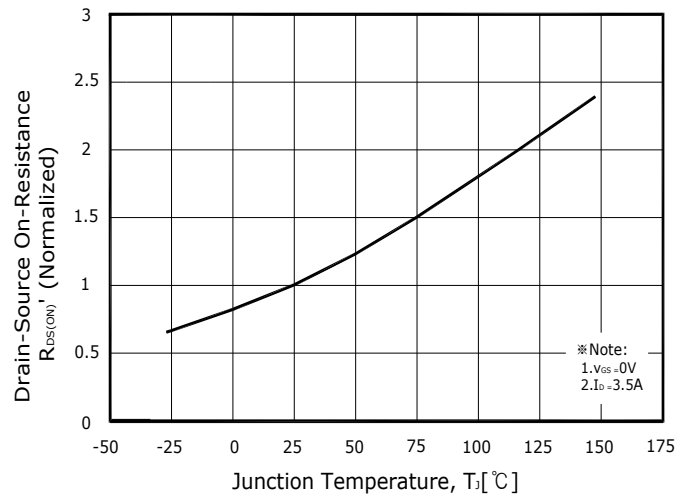

Fig. 9 Safe Operating Area

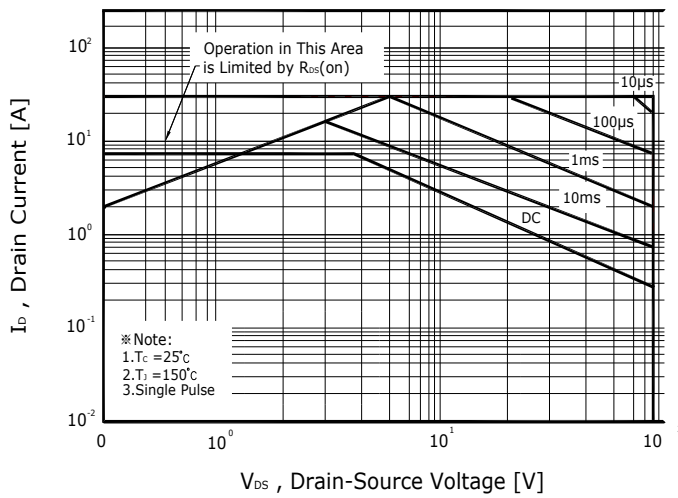

Fig. 10 $I_D - T_C$

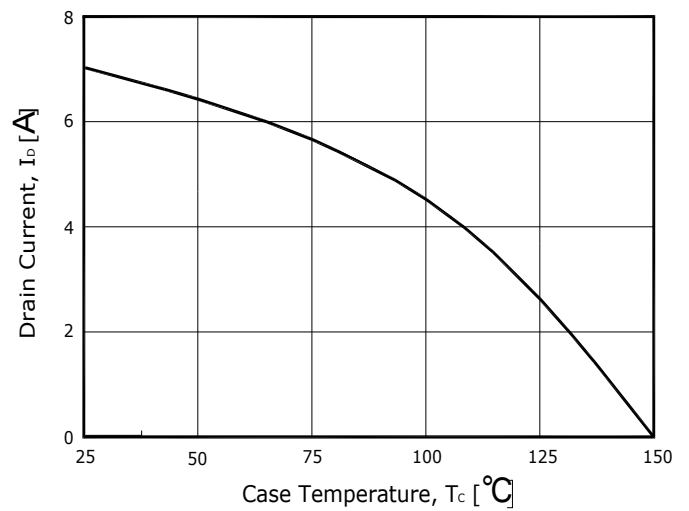

Fig. 11 Gate Charge Test Circuit & Waveform

Fig. 12 Resistive Switching Test Circuit & Waveform

Fig. 13 E_{AS} Test Circuit & Waveform

Fig. 14 Diode Reverse Recovery Time Test Circuit & Waveform

Package Dimensions

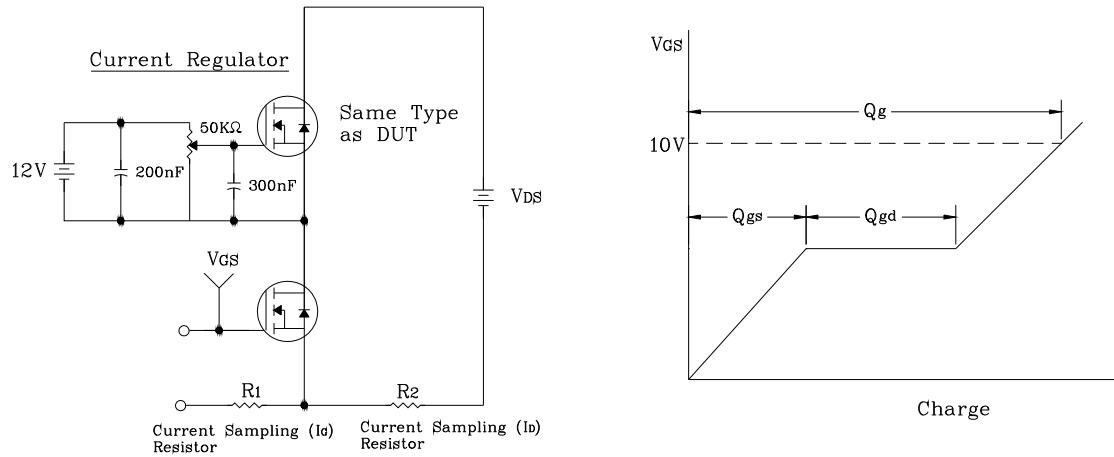
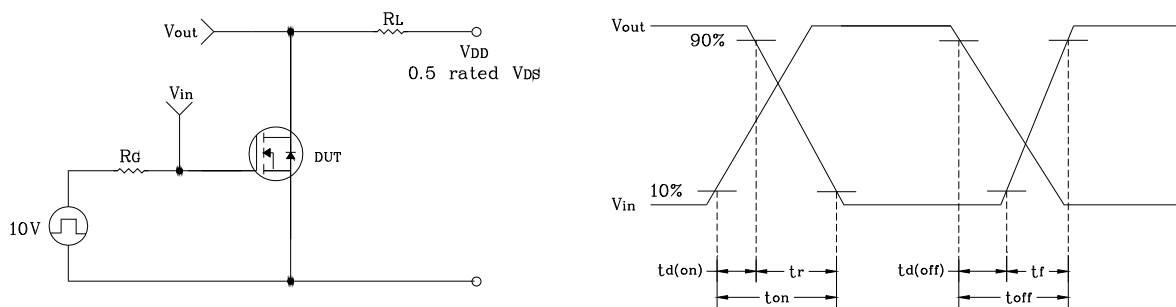
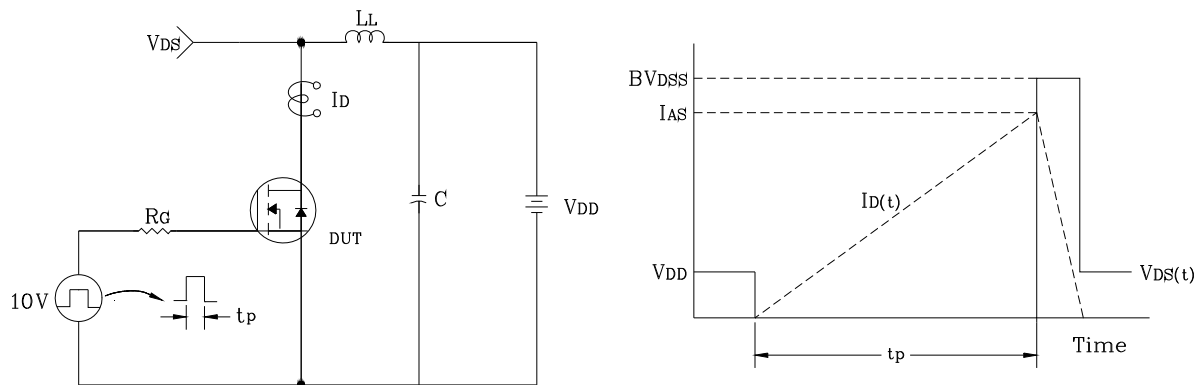
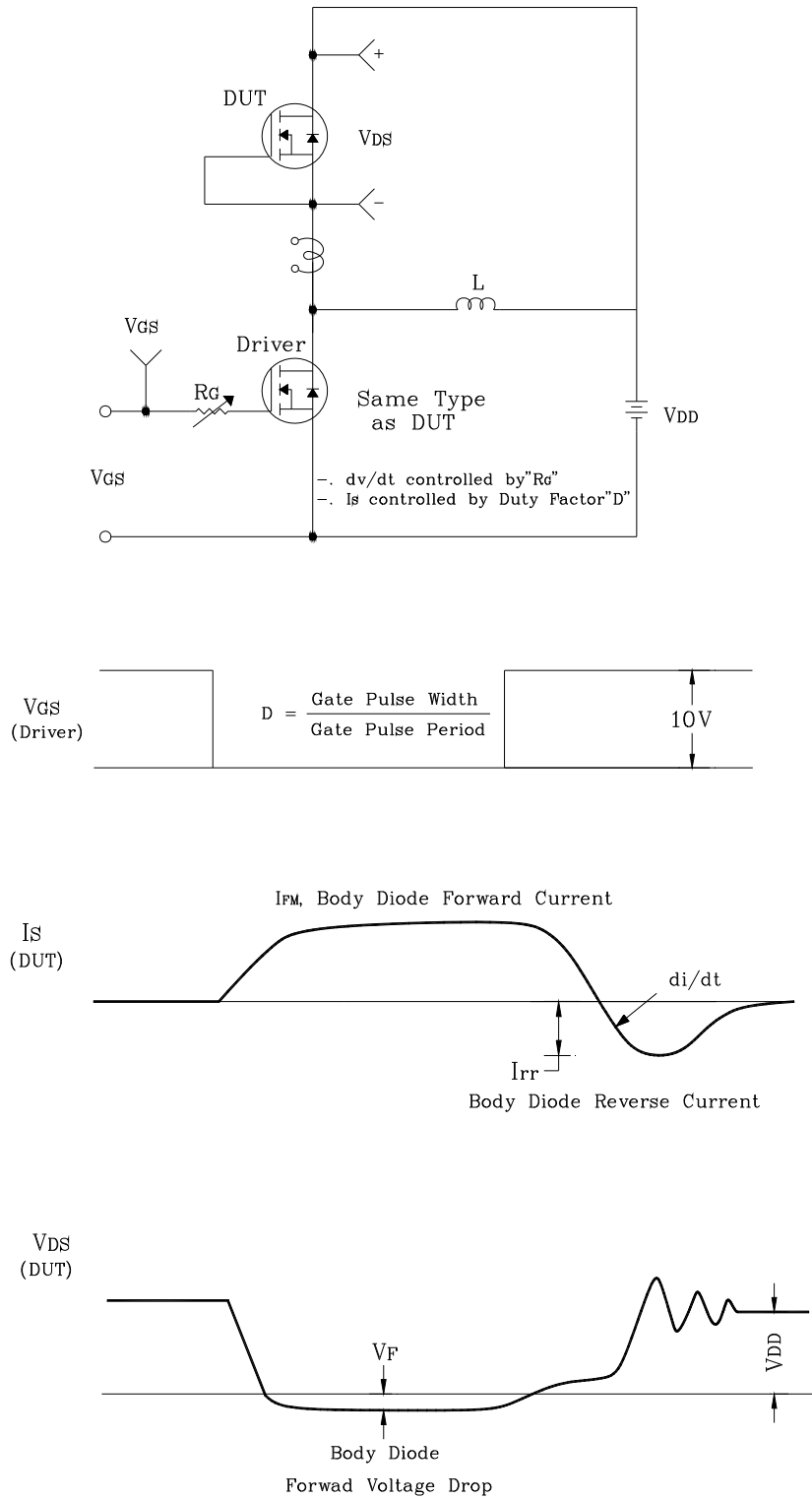
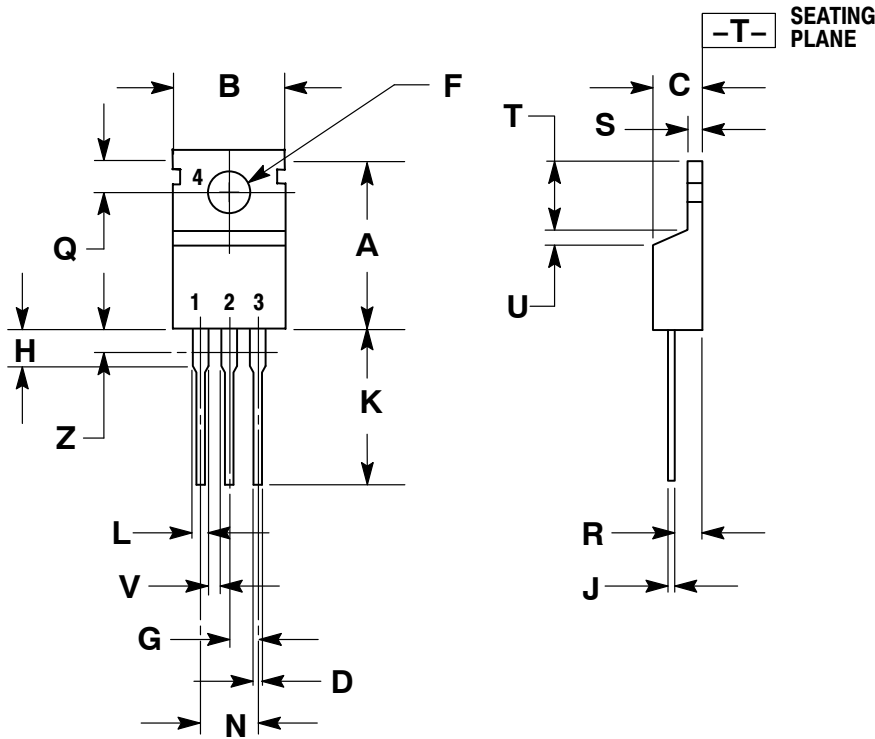
TO-220



NOTES:

1. DIMENSIONING AND TOLERANCING PER ANSI Y14.5M, 1982.
2. CONTROLLING DIMENSION: INCH.
3. DIMENSION Z DEFINES A ZONE WHERE ALL BODY AND LEAD IRREGULARITIES ARE ALLOWED.

DIM	INCHES		MILLIMETERS	
	MIN	MAX	MIN	MAX
A	0.570	0.620	14.48	15.75
B	0.380	0.405	9.66	10.28
C	0.160	0.190	4.07	4.82
D	0.025	0.035	0.64	0.88
F	0.142	0.161	3.61	4.09
G	0.095	0.105	2.42	2.66
H	0.110	0.155	2.80	3.93
J	0.014	0.025	0.36	0.64
K	0.500	0.562	12.70	14.27
L	0.045	0.060	1.15	1.52
N	0.190	0.210	4.83	5.33
Q	0.100	0.120	2.54	3.04
R	0.080	0.110	2.04	2.79
S	0.045	0.055	1.15	1.39
T	0.235	0.255	5.97	6.47
U	0.000	0.050	0.00	1.27
V	0.045	---	1.15	---
Z	---	0.080	---	2.04

STYLE 6:

- PIN 1. ANODE
- 2. CATHODE
- 3. ANODE
- 4. CATHODE