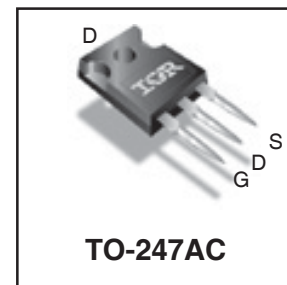
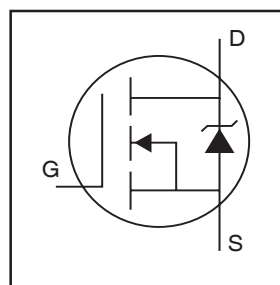


**Features**

- Advanced process technology
- Key parameters optimized for PDP Sustain & Energy Recovery applications
- Low  $E_{PULSE}$  rating to reduce the power dissipation in Sustain & ER applications
- Low  $Q_G$  for fast response
- High repetitive peak current capability for reliable operation
- Short fall & rise times for fast switching
- 175°C operating junction temperature for improved ruggedness
- Repetitive avalanche capability for robustness and reliability

Key Parameters		
$V_{DS}$ min	300	V
$V_{DS}$ (Avalanche) typ.	360	V
$R_{DS(ON)}$ typ. @ 10V	49	mΩ
$I_{RP}$ max @ $T_C = 100^\circ\text{C}$	93	A
$T_J$ max	175	°C



G	D	S
Gate	Drain	Source

**Description**

This HEXFET<sup>®</sup> Power MOSFET is specifically designed for Sustain; Energy Recovery & Pass switch applications in Plasma Display Panels. This MOSFET utilizes the latest processing techniques to achieve low on-resistance per silicon area and low  $E_{PULSE}$  rating. Additional features of this MOSFET are 175°C operating junction temperature and high repetitive peak current capability. These features combine to make this MOSFET a highly efficient, robust and reliable device for PDP driving applications.

**Absolute Maximum Ratings**

	Parameter	Max.	Units
$V_{GS}$	Gate-to-Source Voltage	±30	V
$I_D$ @ $T_C = 25^\circ\text{C}$	Continuous Drain Current, $V_{GS}$ @ 10V	46	A
$I_D$ @ $T_C = 100^\circ\text{C}$	Continuous Drain Current, $V_{GS}$ @ 10V	33	
$I_{DM}$	Pulsed Drain Current ①	190	
$I_{RP}$ @ $T_C = 100^\circ\text{C}$	Repetitive Peak Current ⑤	93	
$P_D$ @ $T_C = 25^\circ\text{C}$	Power Dissipation	430	W
$P_D$ @ $T_C = 100^\circ\text{C}$	Power Dissipation	210	
	Linear Derating Factor	2.9	W/°C
$T_J$ $T_{STG}$	Operating Junction and Storage Temperature Range	-40 to + 175	°C
	Soldering Temperature for 10 seconds	300	
	Mounting Torque, 6-32 or M3 Screw	10lb·in (1.1N·m)	
			N

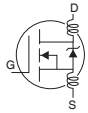
**Thermal Resistance**

	Parameter	Typ.	Max.	Units
$R_{\theta JC}$	Junction-to-Case ④	—	0.35	°C/W

Notes ① through ⑤ are on page 8

## Electrical Characteristics @ $T_J = 25^\circ\text{C}$ (unless otherwise specified)

	Parameter	Min.	Typ.	Max.	Units	Conditions
$BV_{DSS}$	Drain-to-Source Breakdown Voltage	300	—	—	V	$V_{GS} = 0V, I_D = 250\mu A$
$\Delta BV_{DSS}/\Delta T_J$	Breakdown Voltage Temp. Coefficient	—	220	—	mV/ $^\circ\text{C}$	Reference to $25^\circ\text{C}, I_D = 1mA$
$R_{DS(on)}$	Static Drain-to-Source On-Resistance	—	49	59	m $\Omega$	$V_{GS} = 10V, I_D = 33A$ ③
$V_{GS(th)}$	Gate Threshold Voltage	3.0	—	5.0	V	$V_{DS} = V_{GS}, I_D = 250\mu A$
$\Delta V_{GS(th)}/\Delta T_J$	Gate Threshold Voltage Coefficient	—	-15	—	mV/ $^\circ\text{C}$	
$I_{DSS}$	Drain-to-Source Leakage Current	—	—	5.0	$\mu A$	$V_{DS} = 240V, V_{GS} = 0V$
		—	—	150		$V_{DS} = 240V, V_{GS} = 0V, T_J = 125^\circ\text{C}$
$I_{GSS}$	Gate-to-Source Forward Leakage	—	—	100	nA	$V_{GS} = 20V$
	Gate-to-Source Reverse Leakage	—	—	-100		$V_{GS} = -20V$
$g_{fs}$	Forward Transconductance	78	—	—	S	$V_{DS} = 25V, I_D = 33A$
$Q_g$	Total Gate Charge	—	165	247	nC	$V_{DD} = 150V, I_D = 33A, V_{GS} = 10V$ ③
$Q_{gd}$	Gate-to-Drain Charge	—	61	—		
$t_{st}$	Shoot Through Blocking Time	100	—	—	ns	$V_{DD} = 240V, V_{GS} = 15V, R_G = 5.1\Omega$
$E_{PULSE}$	Energy per Pulse	—	1960	—	$\mu J$	$L = 220nH, C = 0.4\mu F, V_{GS} = 15V$ $V_{DS} = 240V, R_G = 4.7\Omega, T_J = 25^\circ\text{C}$
		—	3740	—		$L = 220nH, C = 0.4\mu F, V_{GS} = 15V$ $V_{DS} = 240V, R_G = 4.7\Omega, T_J = 100^\circ\text{C}$
$C_{iss}$	Input Capacitance	—	7370	—	pF	$V_{GS} = 0V$
$C_{oss}$	Output Capacitance	—	520	—		$V_{DS} = 25V$
$C_{riss}$	Reverse Transfer Capacitance	—	220	—		$f = 1.0MHz$ , See Fig.9
$C_{oss\ eff.}$	Effective Output Capacitance	—	320	—		$V_{GS} = 0V, V_{DS} = 0V$ to $240V$
$L_D$	Internal Drain Inductance	—	5.0	—	nH	Between lead, 6mm (0.25in.) from package and center of die contact
$L_S$	Internal Source Inductance	—	13	—		

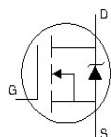


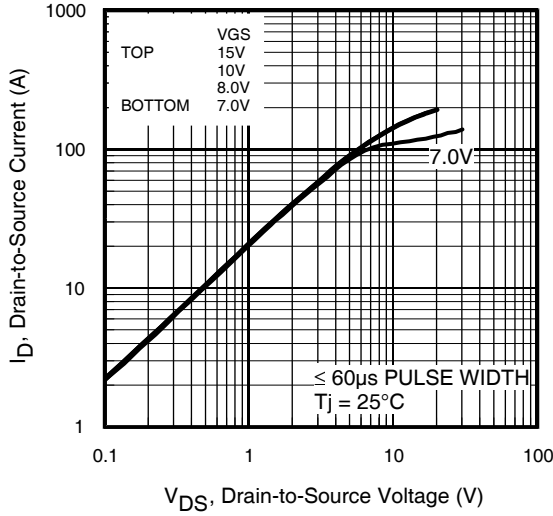
## Avalanche Characteristics

	Parameter	Typ.	Max.	Units
$E_{AS}$	Single Pulse Avalanche Energy ②	—	700	mJ
$E_{AR}$	Repetitive Avalanche Energy ①	—	43	mJ
$V_{DS(Avalanche)}$	Repetitive Avalanche Voltage ①	360	—	V
$I_{AS}$	Avalanche Current ②	—	33	A

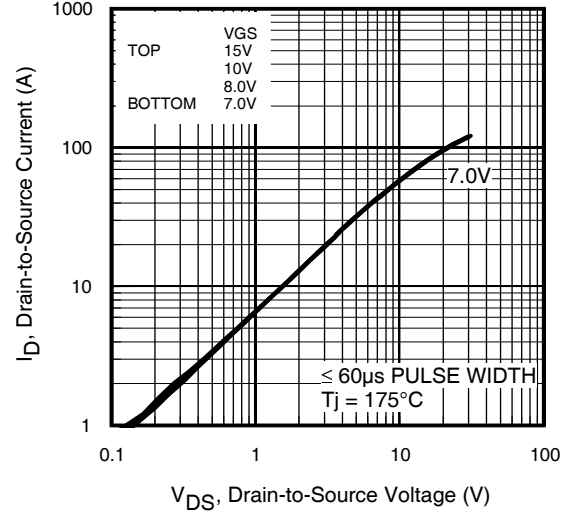
## Diode Characteristics

	Parameter	Min.	Typ.	Max.	Units	Conditions
$I_S @ T_C = 25^\circ\text{C}$	Continuous Source Current (Body Diode)	—	—	46	A	MOSFET symbol showing the integral reverse p-n junction diode.
$I_{SM}$	Pulsed Source Current (Body Diode) ①	—	—	190		
$V_{SD}$	Diode Forward Voltage	—	—	1.0	V	$T_J = 25^\circ\text{C}, I_S = 33A, V_{GS} = 0V$ ③
$t_{rr}$	Reverse Recovery Time	—	300	450	ns	$T_J = 25^\circ\text{C}, I_F = 33A, V_{DD} = 50V$
$Q_{rr}$	Reverse Recovery Charge	—	2330	3500	nC	$di/dt = 100A/\mu s$ ③

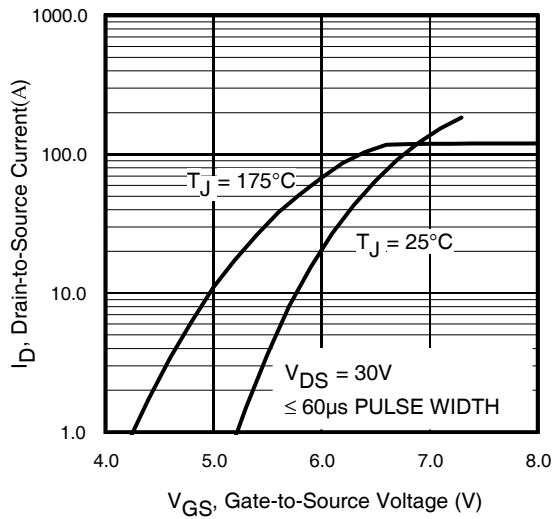




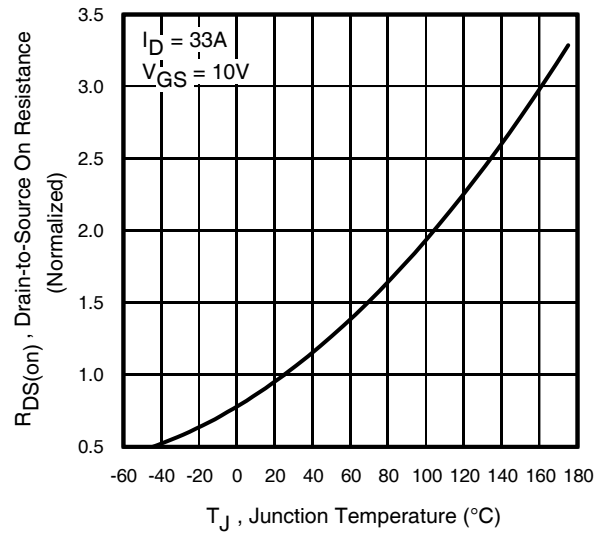
**Fig 1.** Typical Output Characteristics



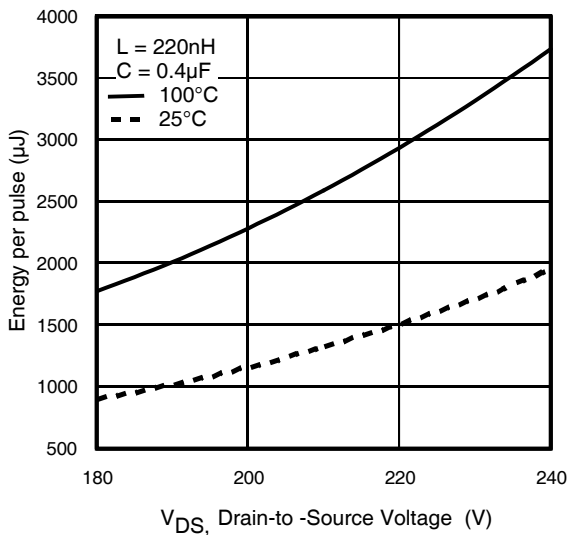
**Fig 2.** Typical Output Characteristics



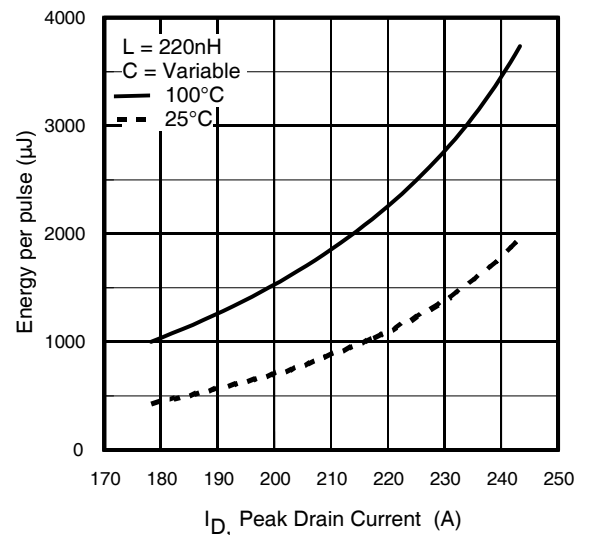
**Fig 3.** Typical Transfer Characteristics



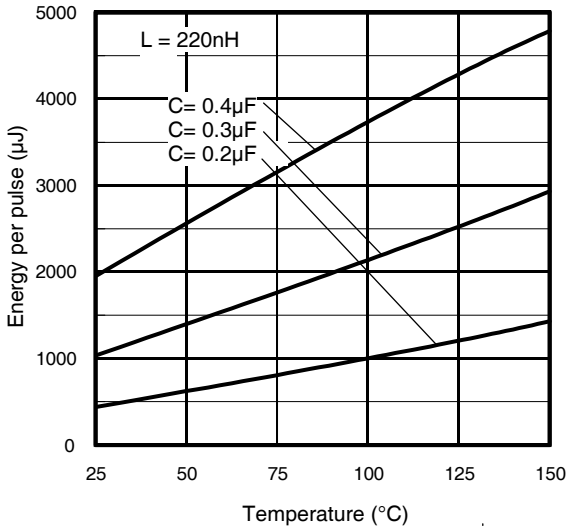
**Fig 4.** Normalized On-Resistance vs. Temperature



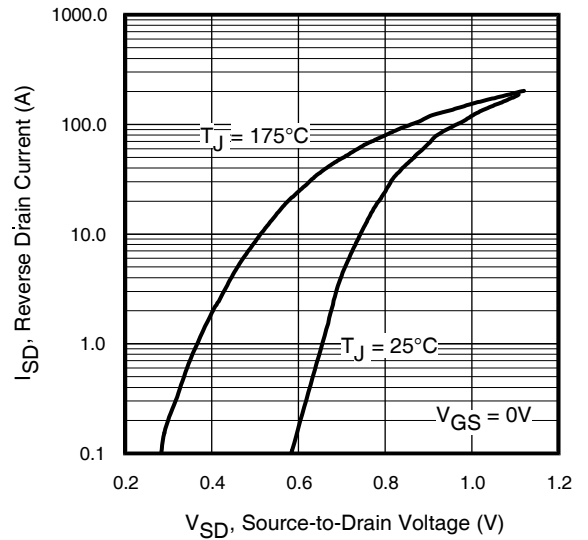
**Fig 5.** Typical  $E_{PULSE}$  vs. Drain-to-Source Voltage



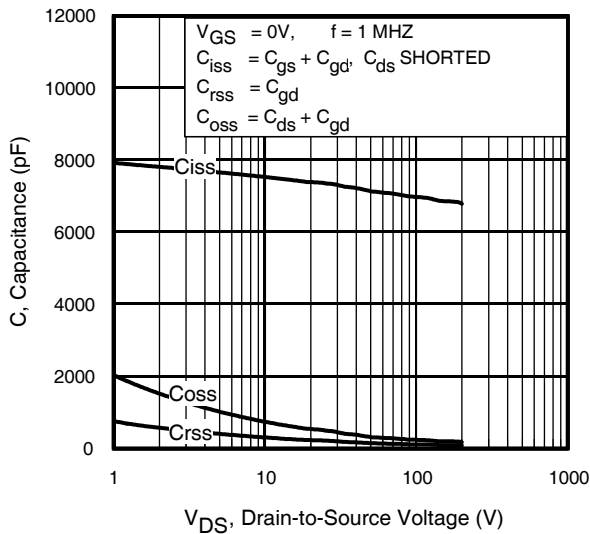
**Fig 6.** Typical  $E_{PULSE}$  vs. Drain Current



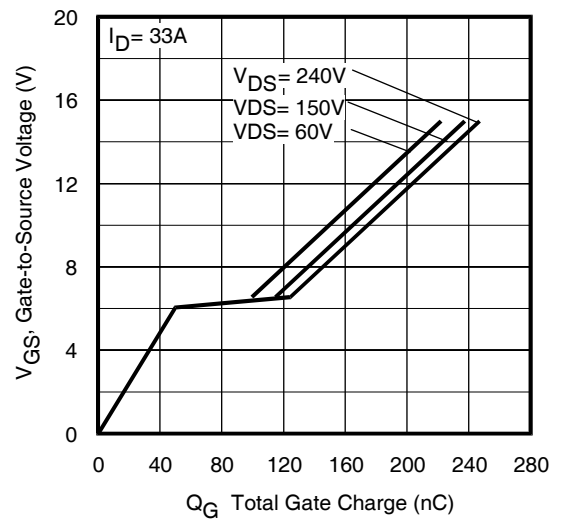
**Fig 7.** Typical  $E_{\text{PULSE}}$  vs. Temperature



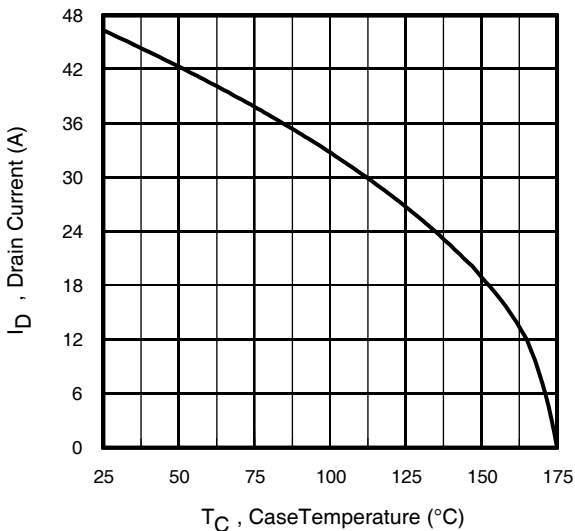
**Fig 8.** Typical Source-Drain Diode Forward Voltage



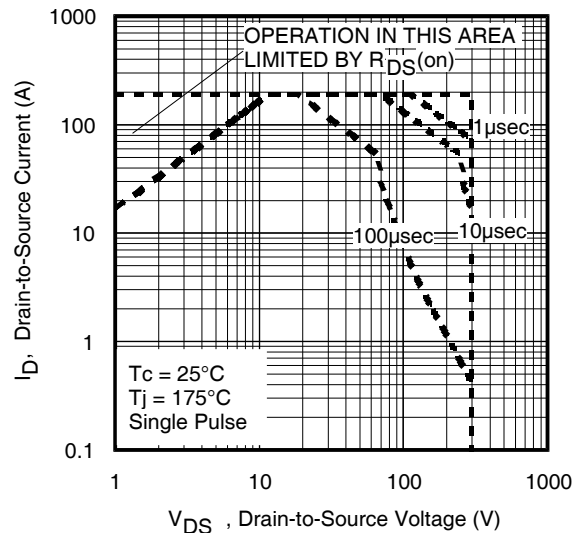
**Fig 9.** Typical Capacitance vs. Drain-to-Source Voltage



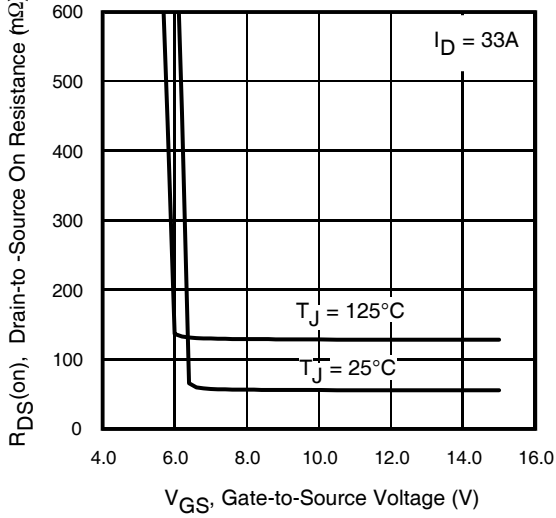
**Fig 10.** Typical Gate Charge vs. Gate-to-Source Voltage



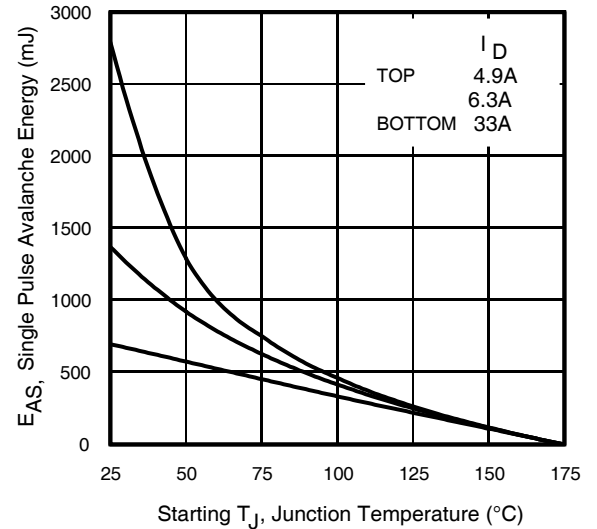
**Fig 11.** Maximum Drain Current vs. Case Temperature



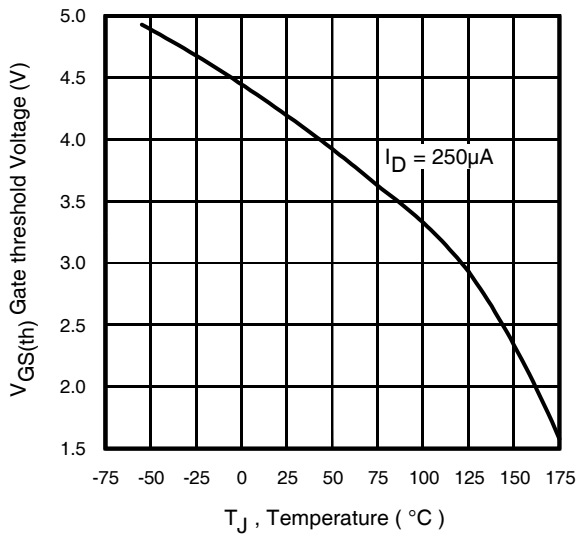
**Fig 12.** Maximum Safe Operating Area



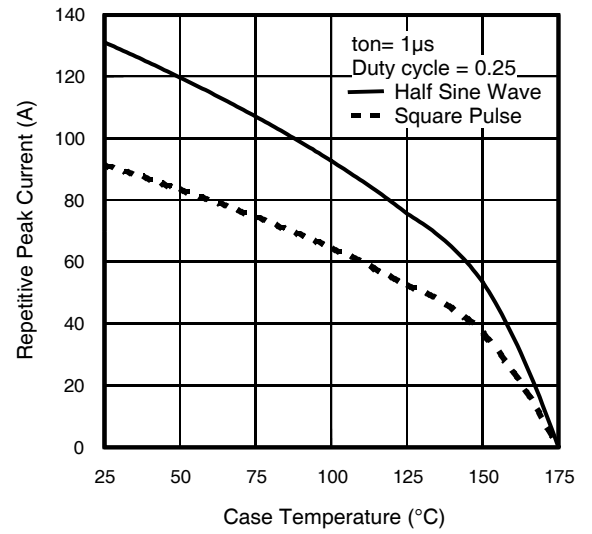
**Fig 13.** On-Resistance Vs. Gate Voltage



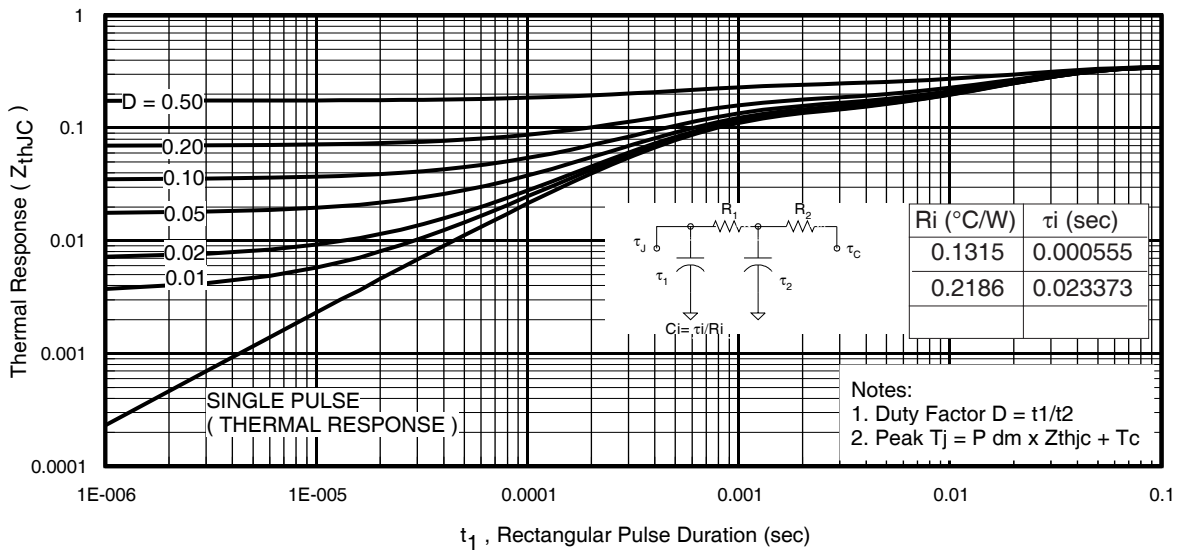
**Fig 14.** Maximum Avalanche Energy Vs. Temperature



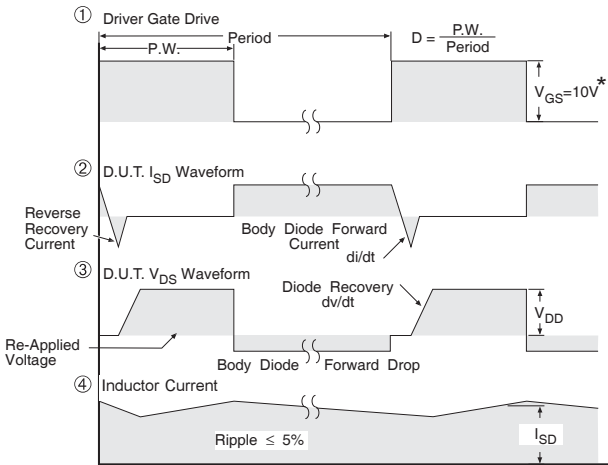
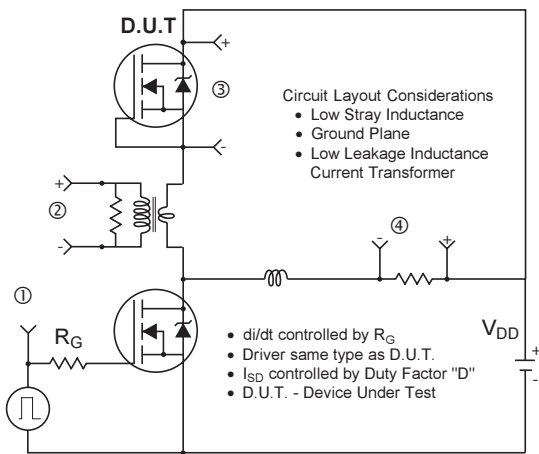
**Fig 15.** Threshold Voltage vs. Temperature



**Fig 16.** Typical Repetitive peak Current vs. Case temperature

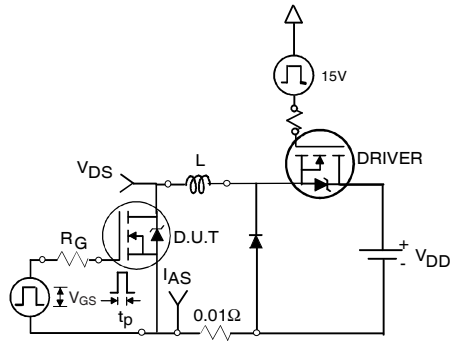


**Fig 17.** Maximum Effective Transient Thermal Impedance, Junction-to-Case

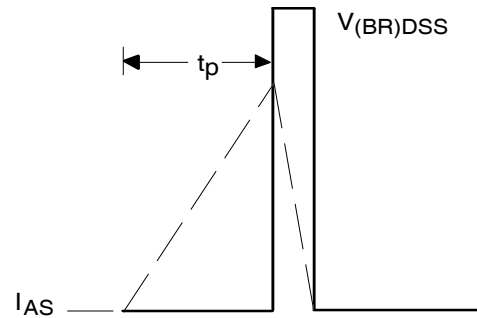


\*  $V_{GS} = 5V$  for Logic Level Devices

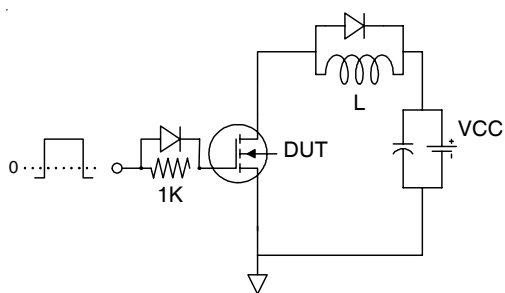
**Fig 18.** Diode Reverse Recovery Test Circuit for N-Channel HEXFET<sup>®</sup> Power MOSFETs



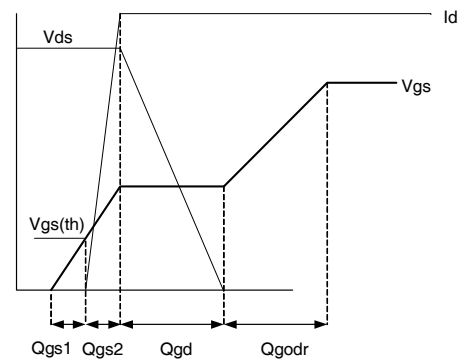
**Fig 19a.** Unclamped Inductive Test Circuit



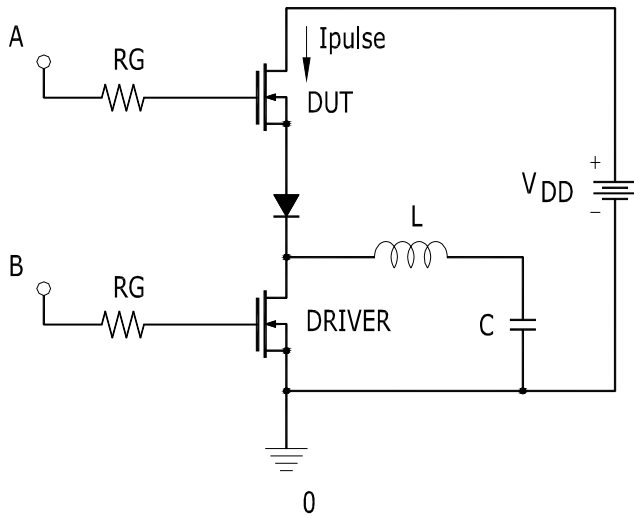
**Fig 19b.** Unclamped Inductive Waveforms



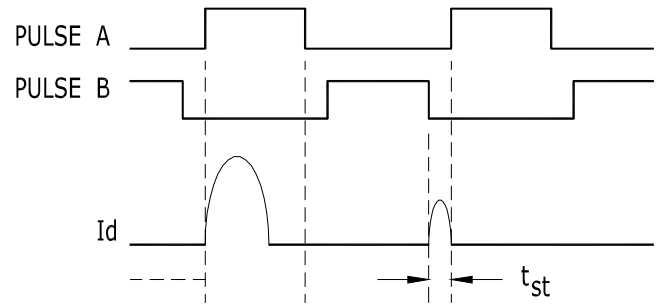
**Fig 20a.** Gate Charge Test Circuit



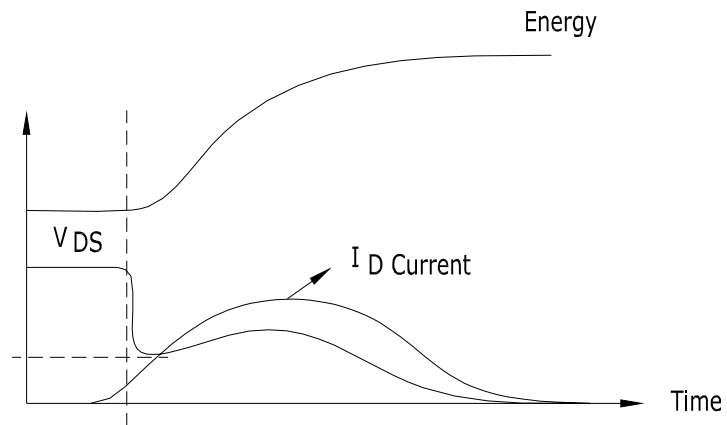
**Fig 20b.** Gate Charge Waveform



**Fig 21a.**  $t_{st}$  and  $E_{PULSE}$  Test Circuit



**Fig 21b.**  $t_{st}$  Test Waveforms

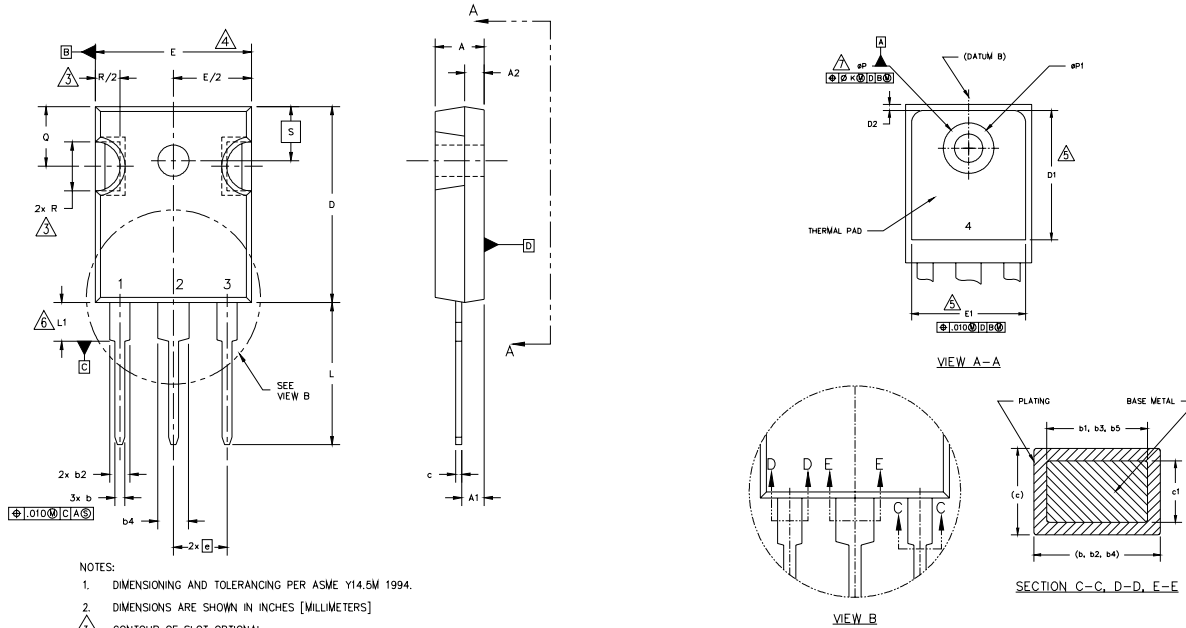


**Fig 21c.**  $E_{PULSE}$  Test Waveforms

# IRFP4242PbF

## TO-247AC Package Outline

Dimensions are shown in millimeters (inches)



- NOTES:
1. DIMENSIONING AND TOLERANCING PER ASME Y14.5M 1994.
  2. DIMENSIONS ARE SHOWN IN INCHES [MILLIMETERS]
  3. CONTOUR OF SLOT OPTIONAL.
  4. DIMENSION D & E DO NOT INCLUDE MOLD FLASH. MOLD FLASH SHALL NOT EXCEED .005" (0.127) PER SIDE. THESE DIMENSIONS ARE MEASURED AT THE OUTERMOST EXTREMES OF THE PLASTIC BODY.
  5. THERMAL PAD CONTOUR OPTIONAL WITHIN DIMENSIONS D1 & E1.
  6. LEAD FINISH UNCONTROLLED IN L1.
  - ØP TO HAVE A MAXIMUM DRAFT ANGLE OF 1.5° TO THE TOP OF THE PART WITH A MAXIMUM HOLE DIAMETER OF .154" [3.91]
  8. OUTLINE CONFORMS TO JEDEC OUTLINE TO-247 WITH THE EXCEPTION OF DIMENSION c.

SYMBOL	DIMENSIONS				NOTES
	INCHES		MILLIMETERS		
	MIN.	MAX.	MIN.	MAX.	
A	.183	.209	4.65	5.31	
A1	.087	.102	2.21	2.59	
A2	.059	.098	1.50	2.49	
b	.039	.055	0.99	1.40	
b1	.039	.053	0.99	1.35	
b2	.065	.094	1.65	2.39	
b3	.065	.092	1.65	2.37	
b4	.102	.135	2.59	3.43	
b5	.102	.133	2.59	3.38	
c	.015	.034	0.38	0.86	
c1	.015	.030	0.38	0.76	4
D	.776	.815	19.71	20.70	5
D1	.515	-	13.08	-	
D2	.020	.030	0.51	0.76	4
E	.602	.625	15.29	15.87	
E1	.540	-	15.72	-	
e	.215 BSC		5.46 BSC		
Øk	.010		2.54		
L	.559	.634	14.20	16.10	
L1	.146	.169	3.71	4.29	
N	3		7.62 BSC		
ØP	.140	.144	3.56	3.66	
Q	.209	.224	5.31	5.69	
R	.178	.216	4.52	5.49	
S	.217 BSC		5.51 BSC		

**LEAD ASSIGNMENTS**

**HEXFET**

- 1.- GATE
- 2.- DRAIN
- 3.- SOURCE
- 4.- DRAIN

**IGBTs, CoPACK**

- 1.- GATE
- 2.- COLLECTOR
- 3.- EMITTER
- 4.- COLLECTOR

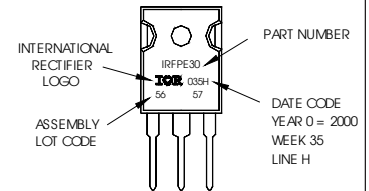
**DIODES**

- 1.- ANODE/OPEN
- 2.- CATHODE
- 3.- ANODE

### TO-247AC Part Marking Information

EXAMPLE: THIS IS AN IRFPE30 WITH ASSEMBLY LOT CODE 5657 ASSEMBLED ON WW 35, 2000 IN THE ASSEMBLY LINE "H"

Note: "P" in assembly line position indicates "Lead-Free"



**TO-247AC package is not recommended for Surface Mount Application.**

**Notes:**

1. Repetitive rating; pulse width limited by max. junction temperature.
2. Starting  $T_J = 25^\circ\text{C}$ ,  $L = 1.28\text{mH}$ ,  $R_G = 25\Omega$ ,  $I_{AS} = 33\text{A}$ .
3. Pulse width  $\leq 400\mu\text{s}$ ; duty cycle  $\leq 2\%$ .
4.  $R_{\theta}$  is measured at  $T_J$  of approximately  $90^\circ\text{C}$ .
5. Half sine wave with duty cycle = 0.25,  $t_{on} = 1\mu\text{sec}$ .

Data and specifications subject to change without notice. This product has been designed for the Industrial market. Qualification Standards can be found on IR's Web site.