

Applications

- High frequency DC-DC converters

V_{DSS}	$R_{DS(on) \max}$	I_D
150V	95mΩ	24A

Benefits

- Low Gate-to-Drain Charge to Reduce Switching Losses
- Fully Characterized Capacitance Including Effective C_{OSS} to Simplify Design, (See App. Note AN1001)
- Fully Characterized Avalanche Voltage and Current

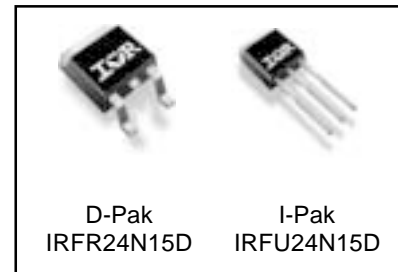

Absolute Maximum Ratings

	Parameter	Max.	Units
$I_D @ T_C = 25^\circ\text{C}$	Continuous Drain Current, $V_{GS} @ 10\text{V}$	24	A
$I_D @ T_C = 100^\circ\text{C}$	Continuous Drain Current, $V_{GS} @ 10\text{V}$	17	
I_{DM}	Pulsed Drain Current ①	96	
$P_D @ T_C = 25^\circ\text{C}$	Power Dissipation	140	W
	Linear Derating Factor	0.92	W/°C
V_{GS}	Gate-to-Source Voltage	± 30	V
dv/dt	Peak Diode Recovery dv/dt ③	4.9	V/ns
T_J	Operating Junction and	-55 to + 175	°C
T_{STG}	Storage Temperature Range		
	Soldering Temperature, for 10 seconds	300 (1.6mm from case)	

Thermal Resistance

	Parameter	Typ.	Max.	Units
$R_{\theta JC}$	Junction-to-Case	—	1.1	°C/W
$R_{\theta JA}$	Junction-to-Ambient (PCB mount)*	—	50	
$R_{\theta JA}$	Junction-to-Ambient	—	110	

Notes ① through ⑤ are on page 10

www.irf.com

IRFR24N15D/IRFU24N15D

International
IR Rectifier

Static @ $T_J = 25^\circ\text{C}$ (unless otherwise specified)

	Parameter	Min.	Typ.	Max.	Units	Conditions
$V_{(BR)DSS}$	Drain-to-Source Breakdown Voltage	150	—	—	V	$V_{GS} = 0V, I_D = 250\mu A$
$\Delta V_{(BR)DSS}/\Delta T_J$	Breakdown Voltage Temp. Coefficient	—	0.18	—	V/°C	Reference to $25^\circ\text{C}, I_D = 1\text{mA}$ ⑥
$R_{DS(on)}$	Static Drain-to-Source On-Resistance	—	82	95	mΩ	$V_{GS} = 10V, I_D = 14A$ ④
$V_{GS(th)}$	Gate Threshold Voltage	3.0	—	5.0	V	$V_{DS} = V_{GS}, I_D = 250\mu A$
I_{DSS}	Drain-to-Source Leakage Current	—	—	25	μA	$V_{DS} = 150V, V_{GS} = 0V$
		—	—	250		$V_{DS} = 120V, V_{GS} = 0V, T_J = 150^\circ\text{C}$
I_{GSS}	Gate-to-Source Forward Leakage	—	—	100	nA	$V_{GS} = 30V$
	Gate-to-Source Reverse Leakage	—	—	-100		$V_{GS} = -30V$

Dynamic @ $T_J = 25^\circ\text{C}$ (unless otherwise specified)

	Parameter	Min.	Typ.	Max.	Units	Conditions
g_{fs}	Forward Transconductance	8.2	—	—	S	$V_{DS} = 25V, I_D = 14A$
Q_g	Total Gate Charge	—	30	45	nC	$I_D = 14A$
Q_{gs}	Gate-to-Source Charge	—	7.4	11		$V_{DS} = 120V$
Q_{gd}	Gate-to-Drain ("Miller") Charge	—	17	26		$V_{GS} = 10V, \text{④}$
$t_{d(on)}$	Turn-On Delay Time	—	11	—	ns	$V_{DD} = 75V$
t_r	Rise Time	—	53	—		$I_D = 14A$
$t_{d(off)}$	Turn-Off Delay Time	—	19	—		$R_G = 6.8\Omega$
t_f	Fall Time	—	15	—		$V_{GS} = 10V, \text{④}$
C_{iss}	Input Capacitance	—	890	—	pF	$V_{GS} = 0V$
C_{oss}	Output Capacitance	—	220	—		$V_{DS} = 25V$
C_{riss}	Reverse Transfer Capacitance	—	46	—		$f = 1.0\text{MHz}$
C_{oss}	Output Capacitance	—	1460	—		$V_{GS} = 0V, V_{DS} = 1.0V, f = 1.0\text{MHz}$
C_{oss}	Output Capacitance	—	95	—		$V_{GS} = 0V, V_{DS} = 120V, f = 1.0\text{MHz}$
$C_{oss\ eff.}$	Effective Output Capacitance	—	200	—		$V_{GS} = 0V, V_{DS} = 0V \text{ to } 120V \text{ ⑤}$

Avalanche Characteristics

	Parameter	Typ.	Max.	Units
E_{AS}	Single Pulse Avalanche Energy②	—	170	mJ
I_{AR}	Avalanche Current①	—	14	A
E_{AR}	Repetitive Avalanche Energy①	—	14	mJ

Diode Characteristics

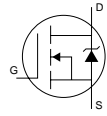
	Parameter	Min.	Typ.	Max.	Units	Conditions
I_S	Continuous Source Current (Body Diode)	—	—	24	A	MOSFET symbol showing the integral reverse p-n junction diode. 
I_{SM}	Pulsed Source Current (Body Diode) ①	—	—	96		
V_{SD}	Diode Forward Voltage	—	—	1.5	V	$T_J = 25^\circ\text{C}, I_S = 14A, V_{GS} = 0V, \text{④}$
t_{rr}	Reverse Recovery Time	—	110	—	ns	$T_J = 25^\circ\text{C}, I_F = 14A$
Q_{rr}	Reverse Recovery Charge	—	450	—	nC	$di/dt = 100A/\mu s, \text{④}$
t_{on}	Forward Turn-On Time	Intrinsic turn-on time is negligible (turn-on is dominated by $L_S + L_D$)				

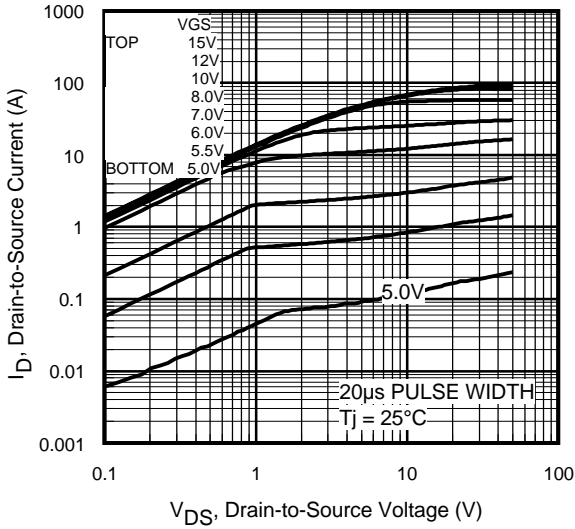

Fig 1. Typical Output Characteristics

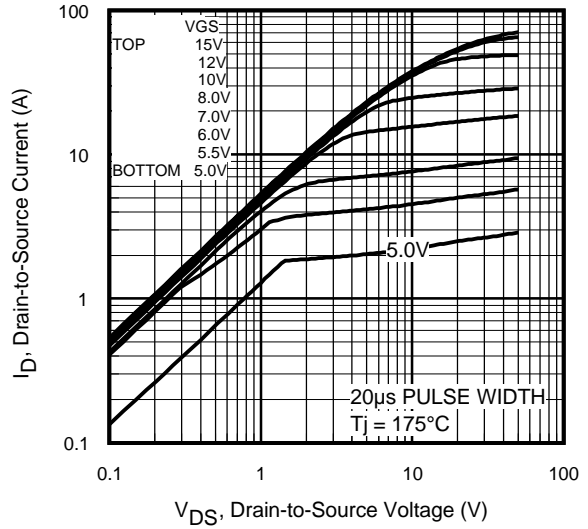

Fig 2. Typical Output Characteristics

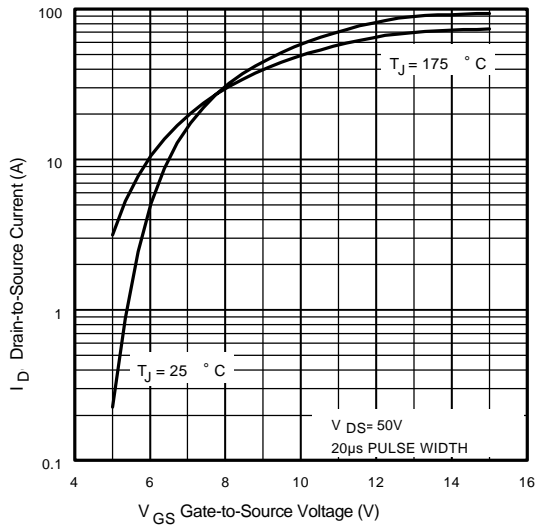

Fig 3. Typical Transfer Characteristics

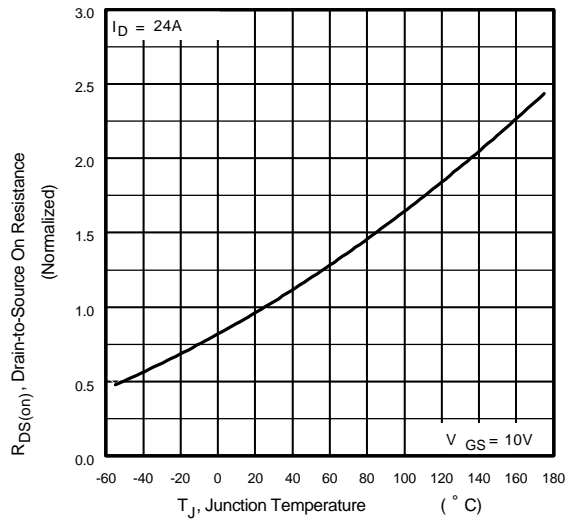

Fig 4. Normalized On-Resistance Vs. Temperature

IRFR24N15D/IRFU24N15D

International
IR Rectifier

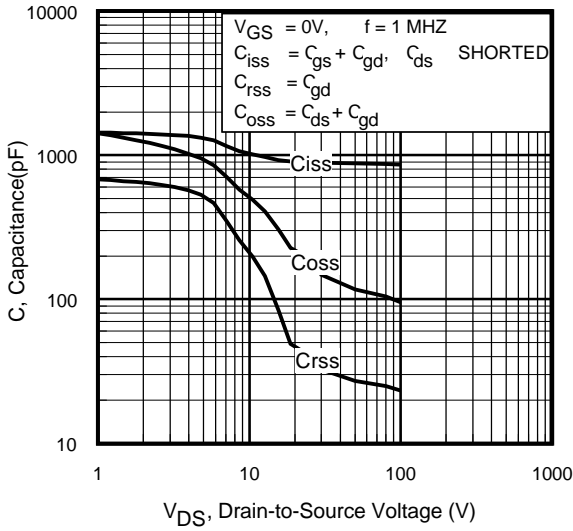

Fig 5. Typical Capacitance Vs. Drain-to-Source Voltage

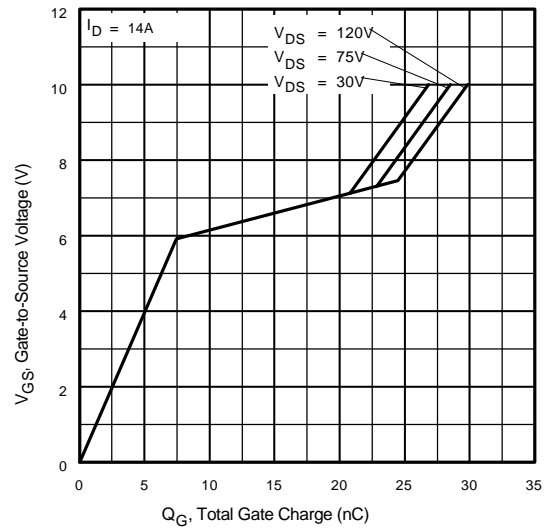

Fig 6. Typical Gate Charge Vs. Gate-to-Source Voltage

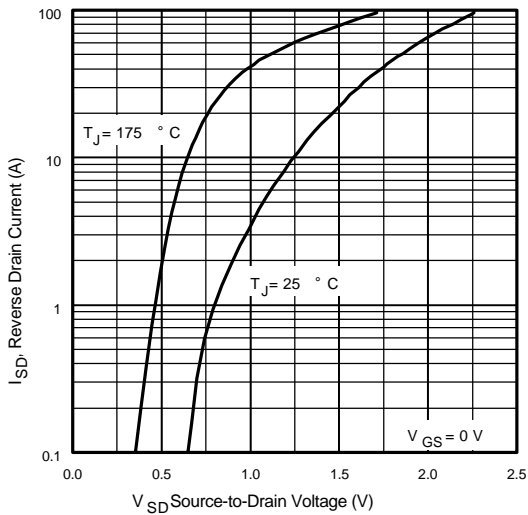

Fig 7. Typical Source-Drain Diode Forward Voltage

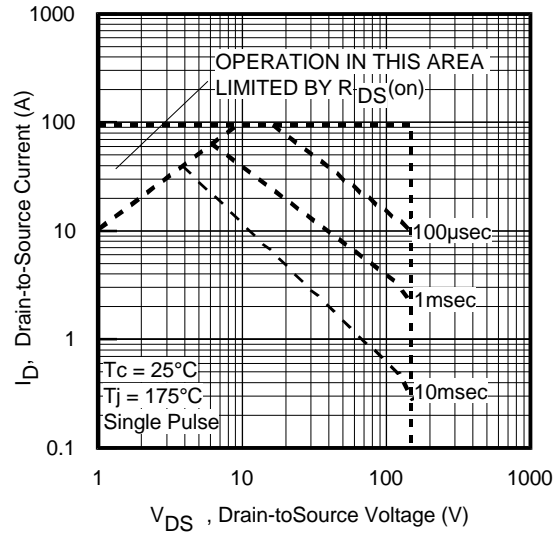

Fig 8. Maximum Safe Operating Area

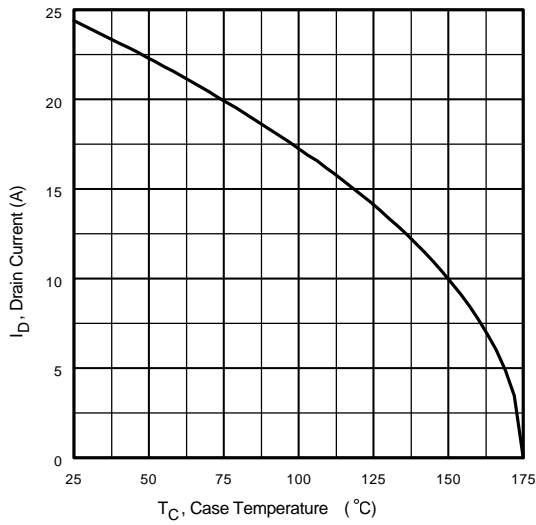

Fig 9. Maximum Drain Current Vs. Case Temperature

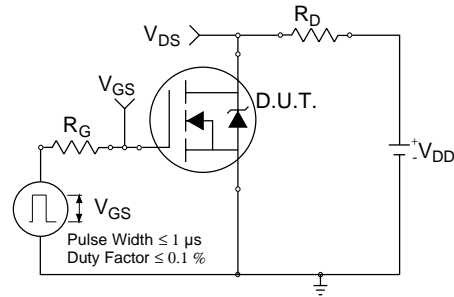

Fig 10a. Switching Time Test Circuit



Fig 10b. Switching Time Waveforms

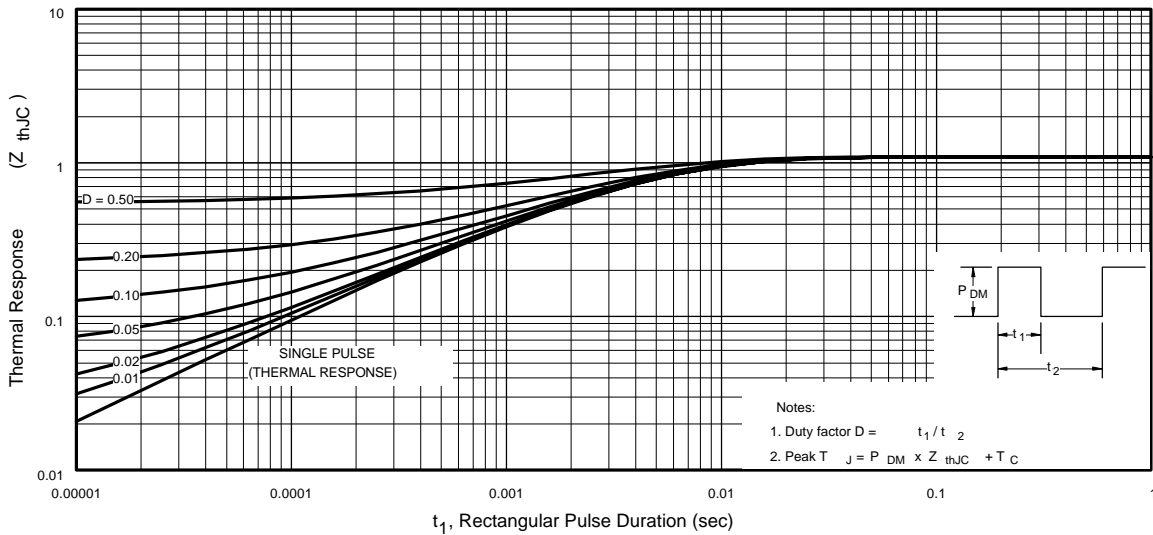

Fig 11. Maximum Effective Transient Thermal Impedance, Junction-to-Case

IRFR24N15D/IRFU24N15D

International
IR Rectifier

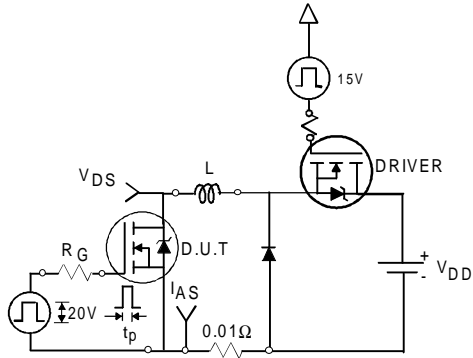

Fig 12a. Unclamped Inductive Test Circuit

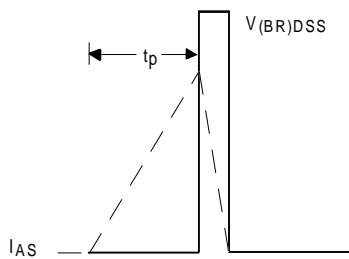

Fig 12b. Unclamped Inductive Waveforms

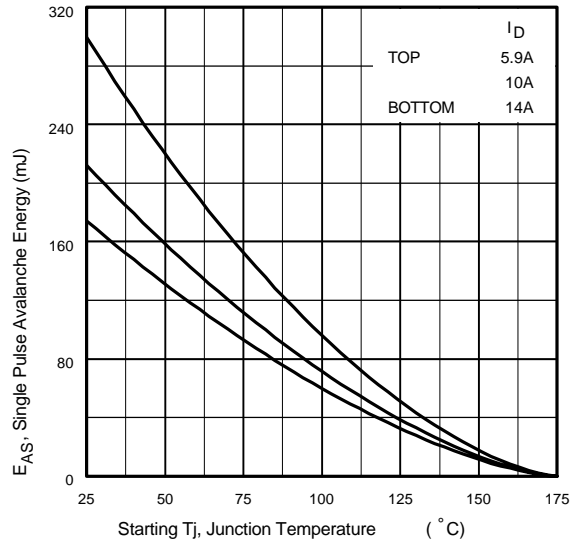

Fig 12c. Maximum Avalanche Energy Vs. Drain Current

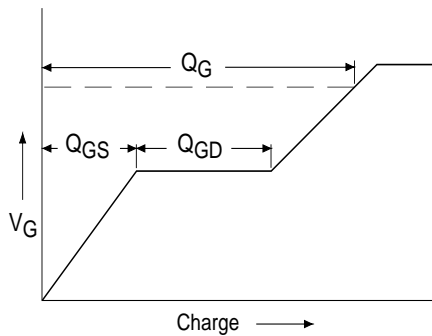

Fig 13a. Basic Gate Charge Waveform

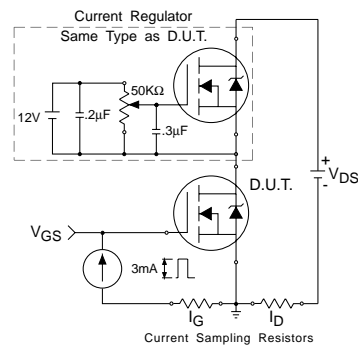
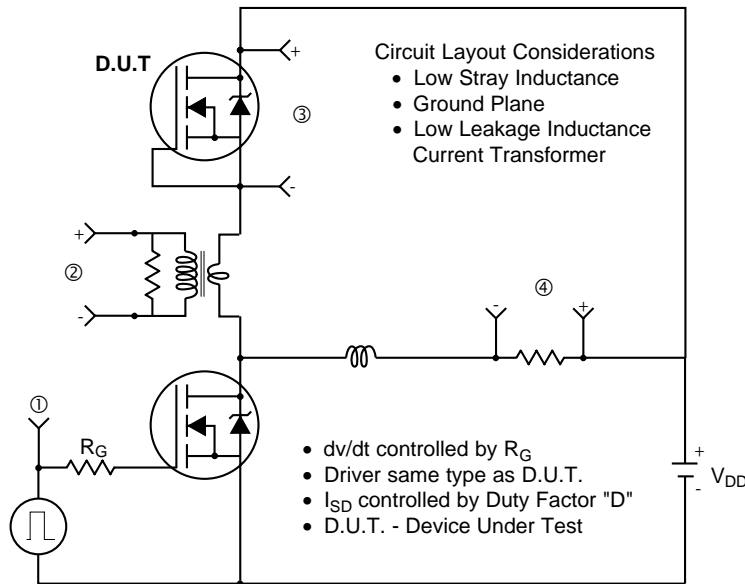

Fig 13b. Gate Charge Test Circuit

Peak Diode Recovery dv/dt Test Circuit



* $V_{GS} = 5V$ for Logic Level Devices

Fig 14. For N-Channel HEXFET® Power MOSFETs

IRFR24N15D/IRFU24N15D

International
IR Rectifier

D-Pak (TO-252AA) Package Outline

Dimensions are shown in millimeters (inches)

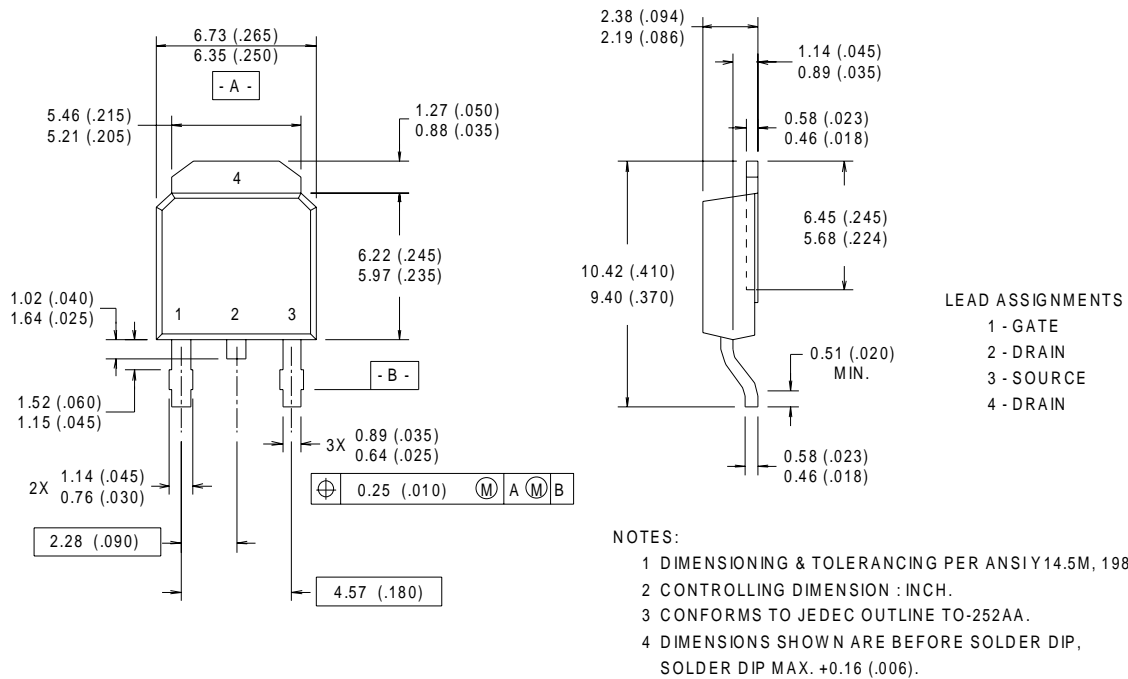

D-Pak (TO-252AA) Part Marking Information

EXAMPLE: THIS IS AN IRFR120
WITH ASSEMBLY
LOT CODE 1234
ASSEMBLED ON WW 16, 1999
IN THE ASSEMBLY LINE "A"

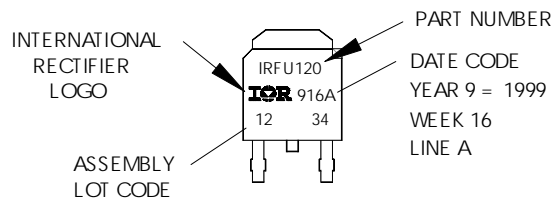

I-Pak (TO-251AA) Package Outline

Dimensions are shown in millimeters (inches)

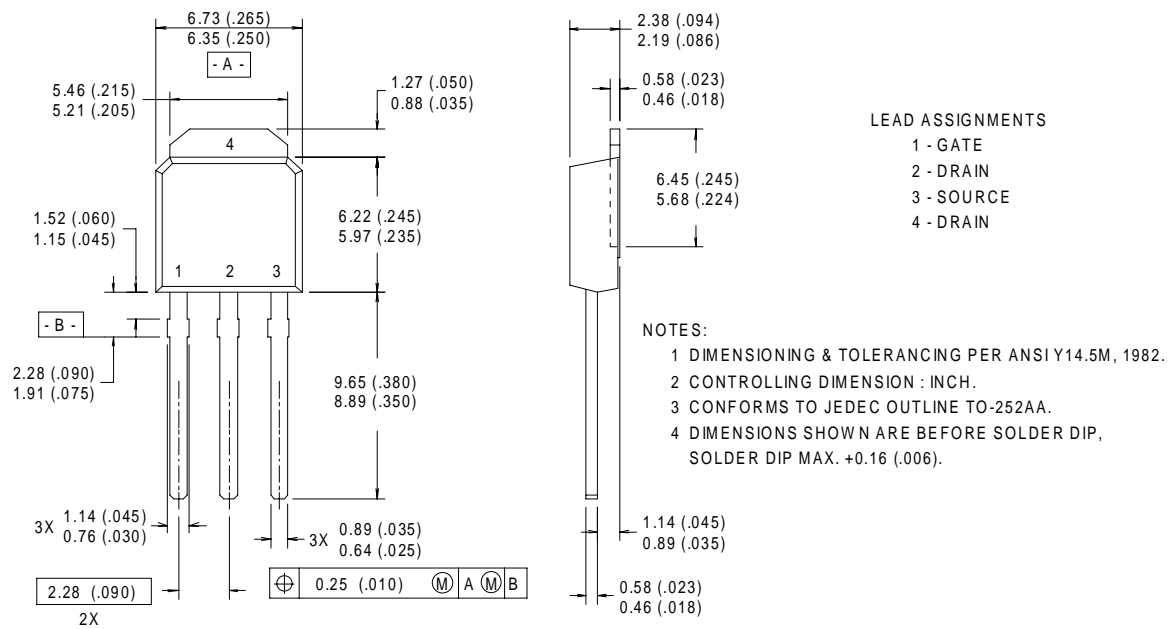

I-Pak (TO-251AA) Part Marking Information

EXAMPLE: THIS IS AN IRFR120
 WITH ASSEMBLY
 LOT CODE 5678
 ASSEMBLED ON WW 19, 1999
 IN THE ASSEMBLY LINE "A"

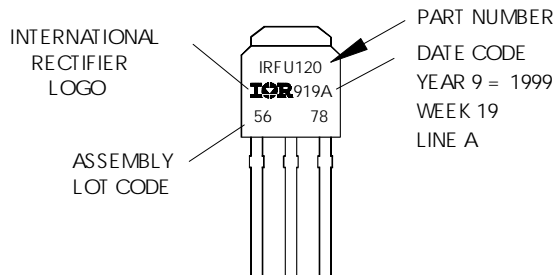

IRFR24N15D/IRFU24N15D

International
IR Rectifier

D-Pak (TO-252AA) Tape & Reel Information

Dimensions are shown in millimeters (inches)

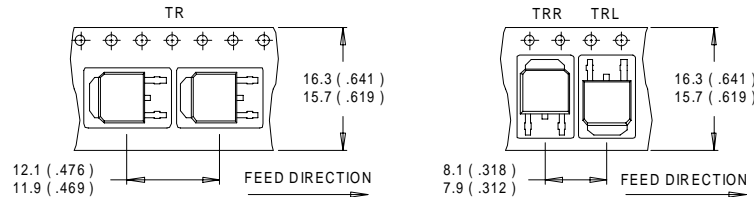

- NOTES :
1. CONTROLLING DIMENSION : MILLIMETER.
 2. ALL DIMENSIONS ARE SHOWN IN MILLIMETERS (INCHES).
 3. OUTLINE CONFORMS TO EIA-481 & EIA-541.

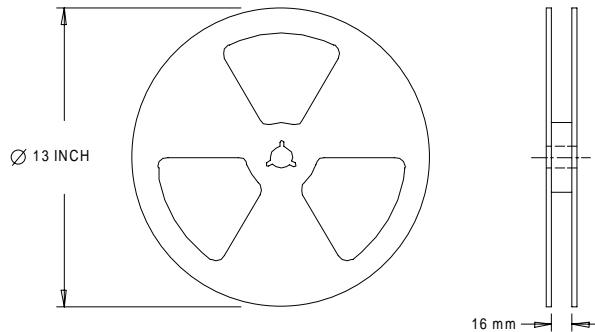

- NOTES :
1. OUTLINE CONFORMS TO EIA-481.

Notes:

- ① Repetitive rating; pulse width limited by max. junction temperature.
 - ② Starting $T_J = 25^\circ\text{C}$, $L = 1.7\text{mH}$
 $R_G = 25\Omega$, $I_{AS} = 14\text{A}$.
 - ③ $I_{SD} \leq 14\text{A}$, $di/dt \leq 380\text{A}/\mu\text{s}$, $V_{DD} \leq V_{(BR)DSS}$,
 $T_J \leq 175^\circ\text{C}$.
 - ④ Pulse width $\leq 300\mu\text{s}$; duty cycle $\leq 2\%$.
 - ⑤ C_{OSS} eff. is a fixed capacitance that gives the same charging time as C_{OSS} while V_{DS} is rising from 0 to 80% V_{DSS} .
- * When mounted on 1" square PCB (FR-4 or G-10 Material).
For recommended footprint and soldering techniques refer to application note #AN-994.

Data and specifications subject to change without notice.
This product has been designed and qualified for the Automotive [Q101] market.
Qualification Standards can be found on IR's Web site.

International
IR Rectifier

IR WORLD HEADQUARTERS: 233 Kansas St., El Segundo, California 90245, USA Tel: (310) 252-7105
TAC Fax: (310) 252-7903

Visit us at www.irf.com for sales contact information.03/02

www.irf.com