

KTIR0811S

Features

- Compact and thin
- Visible light cut-off type
- High sensitivity

Applications

- Cassette tape recorders, VCRs.
- Floppy disk drives.
- Various microcomputerized control equipment.

Package Dimensions

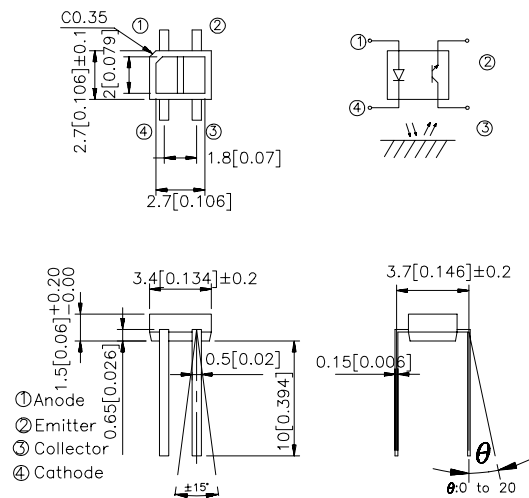

Notes:

1. All dimensions are in millimeters (inches).
2. Tolerance is $\pm 0.25(0.01")$ unless otherwise noted.
3. Lead spacing is measured where the lead emerge package.
4. Specifications are subject to change without notice.

Absolute Maximum Ratings ($T_a=25^\circ\text{C}$)

Parameter		Symbol	Rating	Unit
Input	Forward current	I_F	50	mA
	Reverse voltage	V_R	5	V
	Power dissipation	P	75	mW
Output	Collector-emitter voltage	V_{CEO}	30	V
	Emitter-collector voltage	V_{ECO}	5	V
	Collector current	I_C	20	mA
	Collector power dissipation	P_C	75	mW
Operating temperature		T_{opr}	-25~+85	$^\circ\text{C}$
Storage temperature		T_{stg}	-40~+100	$^\circ\text{C}$
Soldering temperature(1/16 inch from body for 5 seconds)		T_{sol}	260	$^\circ\text{C}$

Electro-optical Characteristics ($T_a=25^\circ\text{C}$)

Parameter		Symbol	Conditions	Min.	Typ.	Max.	Unit
Input	Forward voltage	V_F	$I_F=20\text{mA}$	—	1.2	1.5	V
	Reverse current	I_R	$V_R=5\text{V}$	—	—	10	μA
Output	Collector dark current	I_{CEO}	$V_{CE}=20\text{V}$	—	10^{-9}	10^{-7}	A
Transfer characteristics	*1Collector current	I_c	$V_{CE}=2\text{V}, I_F=4\text{mA}$	—	100	—	μA
	*2Leak current	I_{LEAK}	$V_{CE}=2\text{V}, I_F=4\text{mA}$	—	—	0.1	μA
	Response time	Rise time	t_r	$V_{CE}=2\text{V}, I_C=100\mu\text{A}$ $R_L=1\text{K}\Omega, d=1\text{mm}$	—	20	100
Fall time		t_f	—		20	100	μsec

*1 The condition and arrangement of the reflective object are shown below

*2 Without reflective object

Test Condition and Arrangement for Collector Current

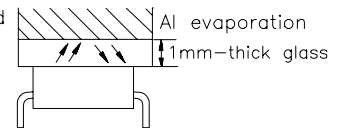

Fig.1 Forward Current vs. Forward Voltage

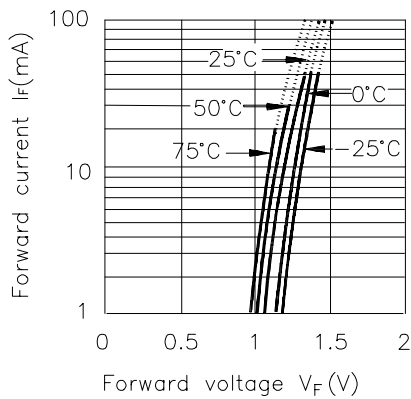

Fig.2 Collector Current vs. Forward Current

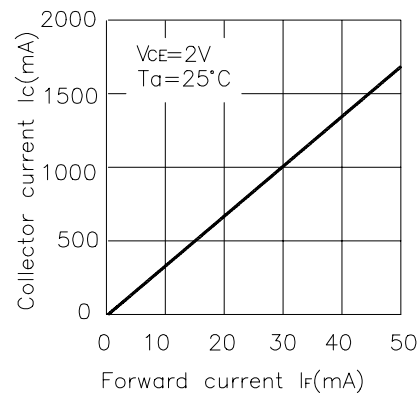

Fig.3 Collector Current vs. Collector-emitter Voltage

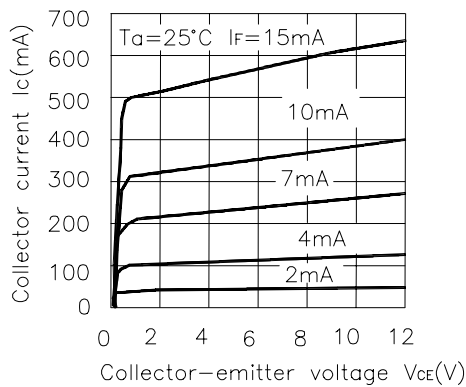

Fig.4 Relative Collector Current vs. Ambient Temperature

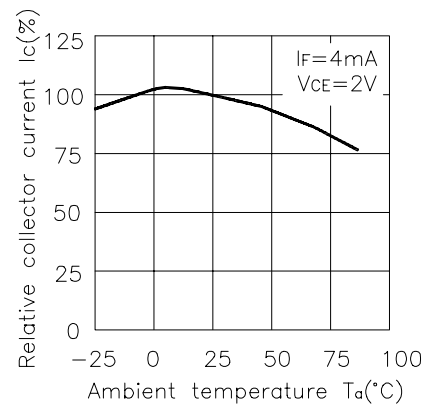
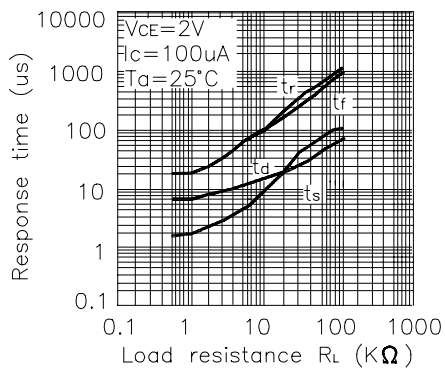

Fig.5 Response Time vs. Load Resistance



Test Circuit for Response Time

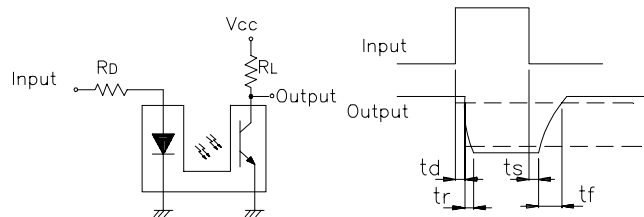

Fig.6 Collector Dark Current vs. Ambient Temperature

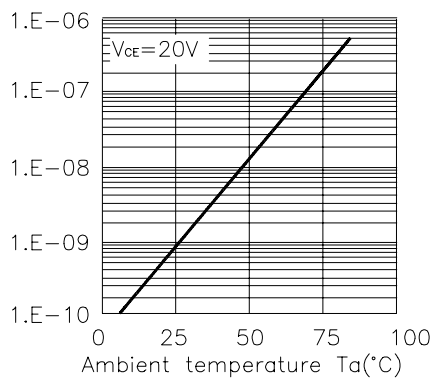

Fig.7 Relative Collector Current vs. Distance between Sensor and Al Evaporation Glass

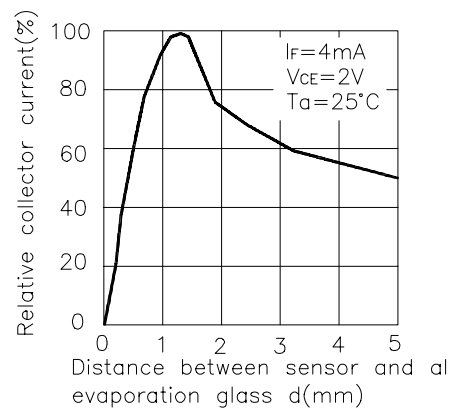

Fig.8 Relative Collector Current vs. Card Moving Distance (1)

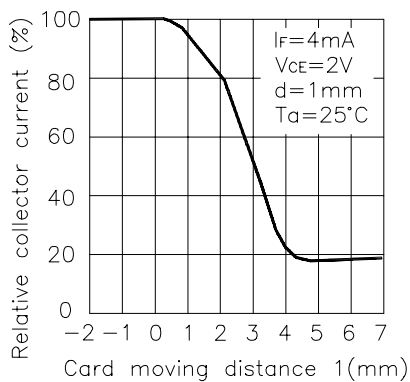
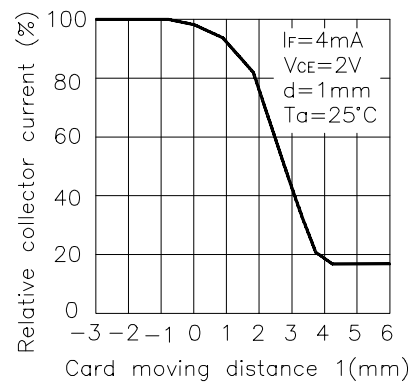
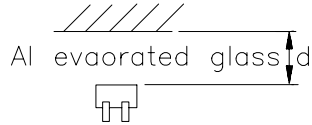

Fig.9 Relative Collector Current vs. Card Moving Distance (2)



The Condition for Distance&Detecting Position Characteristics

Correpond to Fig.7



Correpond to Fig.8
Test condition

$I_F = 4\text{mA}$
 $V_{CE} = 2\text{V}$
 $d = 1\text{mm}$

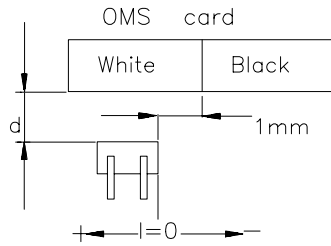

Correpond to Fig.9
Test condition

$I_F = 4\text{mA}$
 $V_{CE} = 2\text{V}$
 $d = 1\text{mm}$

