

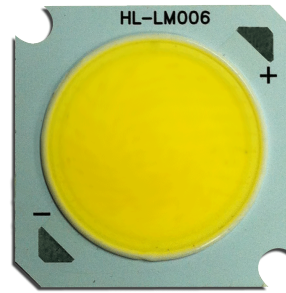

Under Development	●
Mass production	



ATTENTION
OBSERVE PRECAUTIONS
FOR HANDLING
ELECTROSTATIC
DISCHARGE
SENSITIVE
DEVICES



Features

- Dimension 22.0mm×22.0mm×1.5mm
- 7W class high-power LED
- CRI: Ra 80 min
- Luminous Flux: 720 lm @ 180mA
- Wide viewing angle : 120°
- Lambertian radiation pattern
- RoHS compliant

Applications

- Bulb Light
- Down light

Package Dimensions

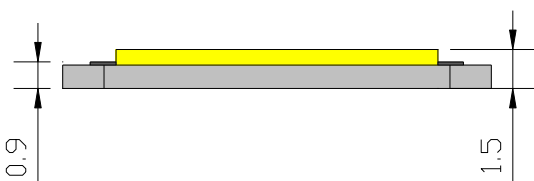
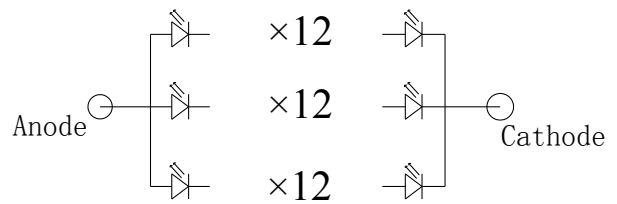
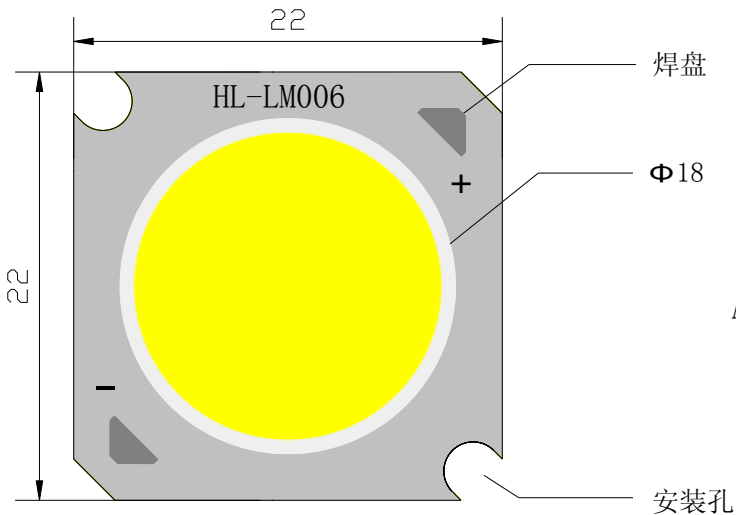

Notes:

1. All dimension units are millimeters.
2. All dimension tolerance is ± 0.2 mm unless otherwise noted.



Specifications

(1) Absolute Maximum Ratings at TA=25°C

Parameter	Symbol	Rating	Units
Power dissipation[1]	Pd	7	W
DC Forward Current[1]	I _F	180	mA
Peak Forward Current (Duty 1/10@1KHZ) [1]	I _{FP}	240	mA
Reverse Voltage[1]	V _R	5	V
Operating Temperature Range	Topr	-20°C To +65°C	
Storage Temperature Range	Tstg	0C To +40°C	

Note:

- 1.1/10 Duty Cycle,0.1ms Pulse Width.
- 2.The temperature of Aluminum PCB do not exceed 55°C.

(2) Electrical / Optical Characteristics at TA=25°C

Parameter	Symbol	Min.	Typ.	Max.	Units	Test Conditions
Color Temperature[4]	TC	6020		7040	K	IF=180mA
Color-rendering index	Ra	80	—	—	—	IF=180mA
Forward Voltage [1]	VF	—	36.0	—	V	IF=180mA
thermal resistance	Rth	—	3.0	—	°C/W	IF=180mA
Luminous Flux	Φ _v	660	720	—	lm	IF=180mA
Reverse Current	IR	—	—	2	uA	VR = 5V

Note:

- 1.For each die.
- 2.θ1/2 is the angle from optical centerline where the luminous Flux is 1/2 the optical centerline value.
- 3.The value only for reference.

(3) Device Selection Guide

Part No.	Chip		Lens Type	
	Material	Emitting Color		
HL-LM006H384W-7B3C12 (Ra2)	InGaN	Blue	cool White	Yellow Diffused



Product bins

Chromaticity bins

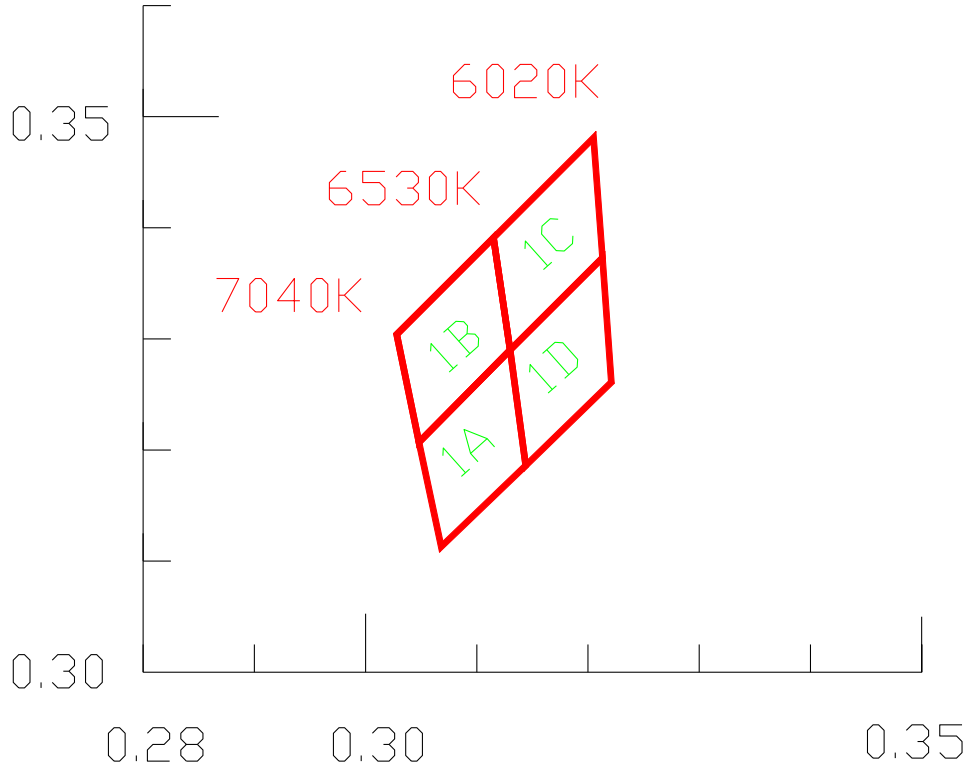

bin code	CIEX	CI EY
1A	0.3048	0.3207
	0.3130	0.3290
	0.3144	0.3186
	0.3068	0.3113
1B	0.3028	0.3304
	0.3115	0.3391
	0.3130	0.3290
	0.3048	0.3207
1C	0.3115	0.3391
	0.3205	0.3481
	0.3213	0.3373
	0.3130	0.3290
1D	0.3130	0.3290
	0.3213	0.3373
	0.3221	0.3261
	0.3144	0.3186



Under Development	●
Mass production	

Spatial Distribution Graph

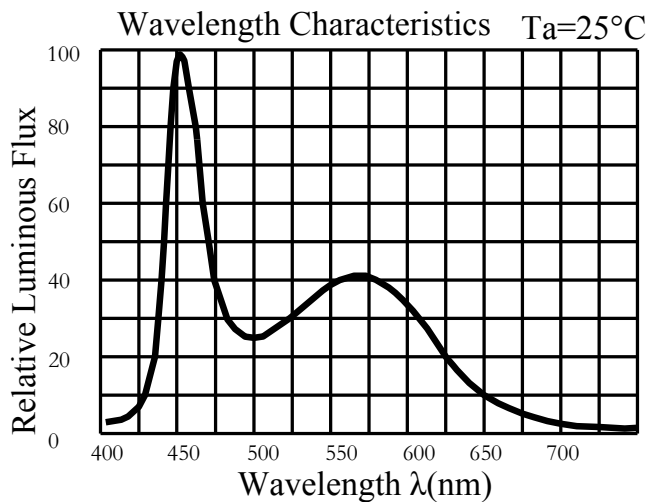
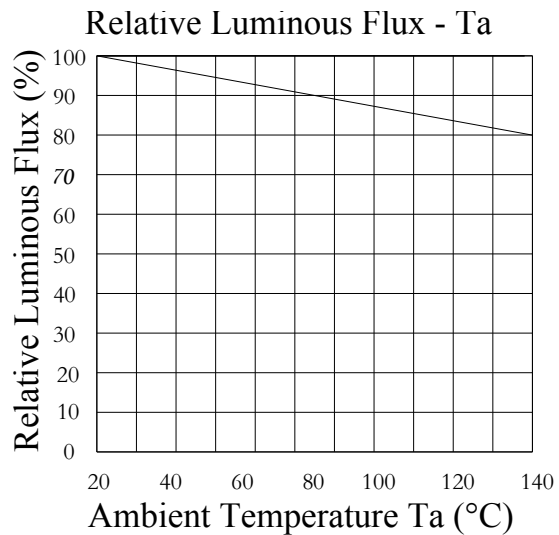
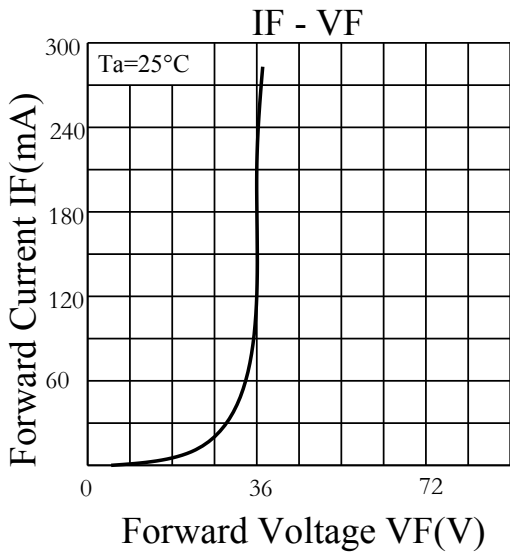
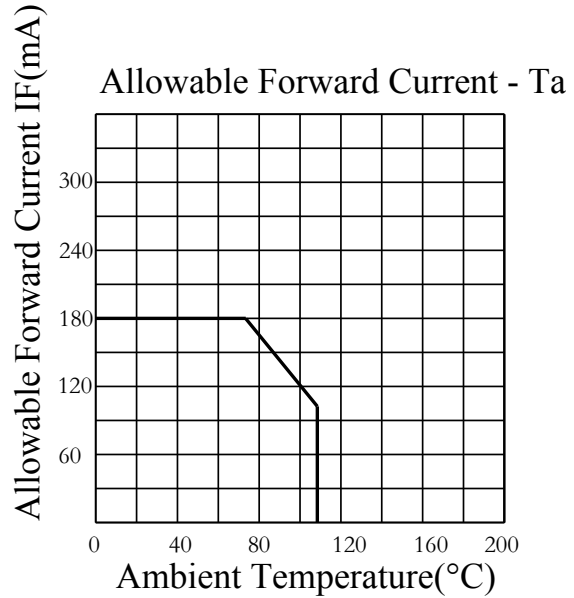
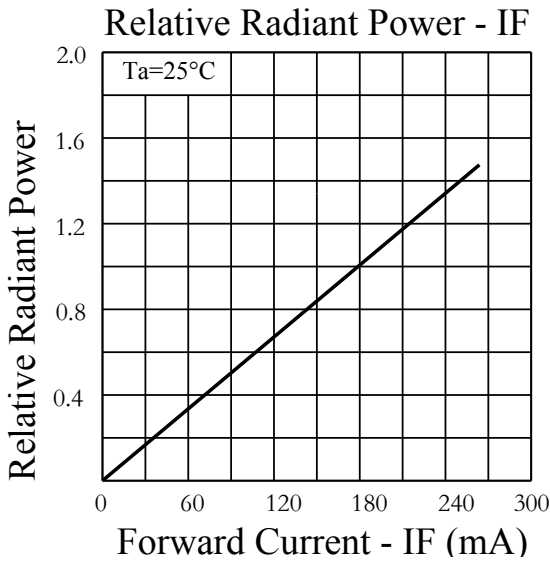



Under Development	●
Mass production	

Spatial Distribution Graph

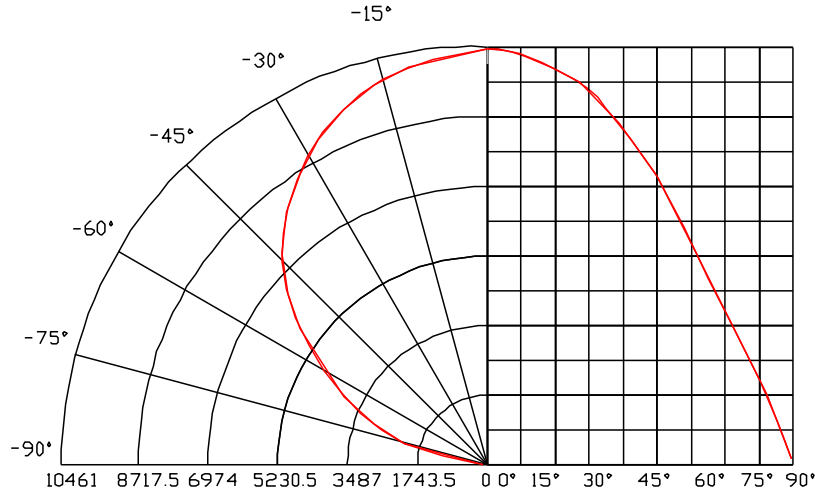

Product Thermal Application Information

Screw M2



Thermal Interface materials



Heat sink

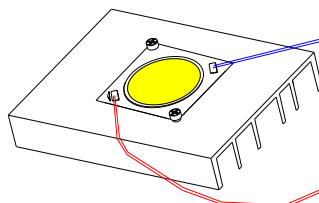
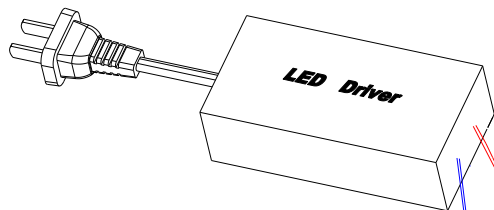
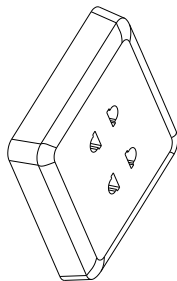



Under Development	●
Mass production	

Tape Specification

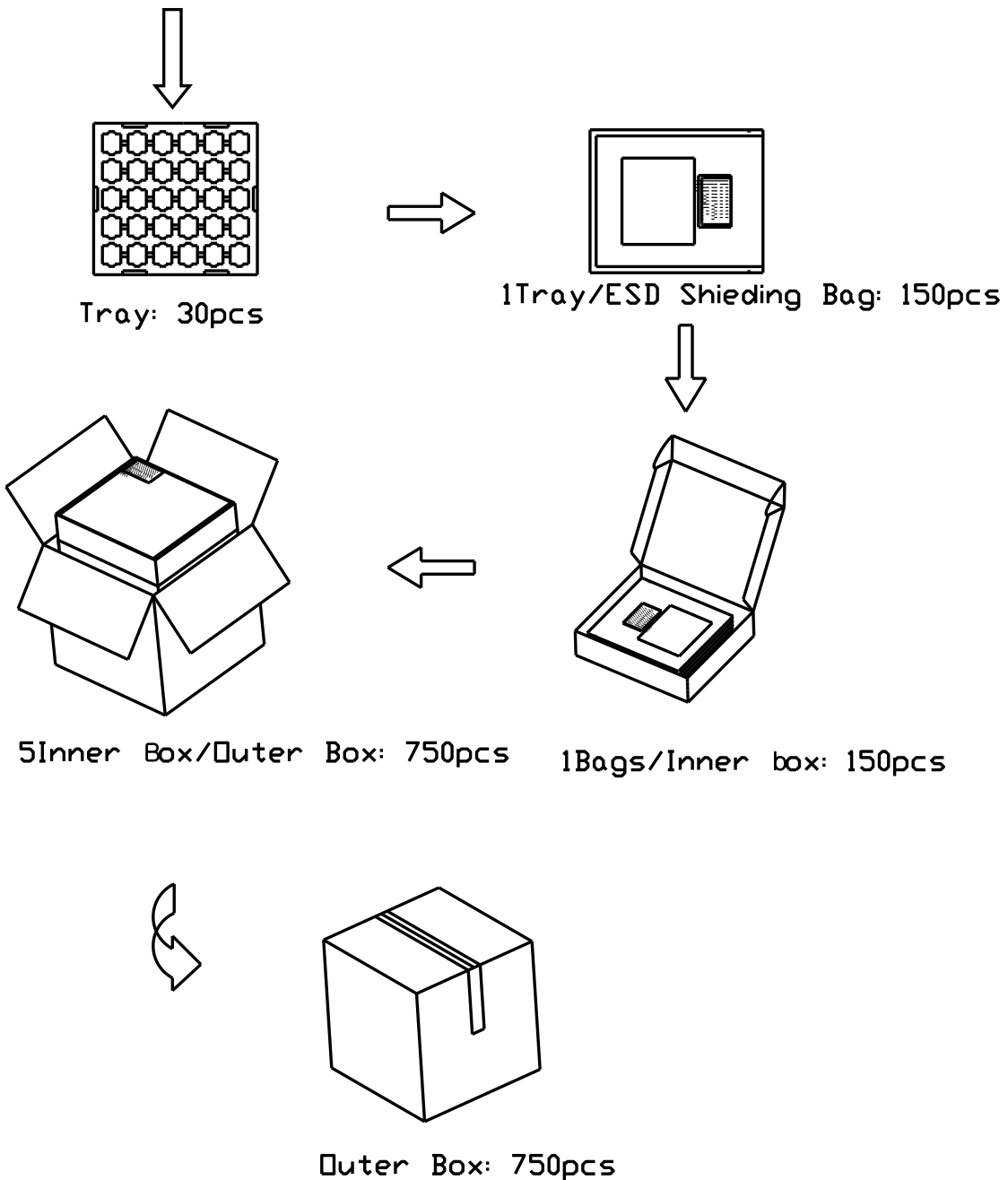
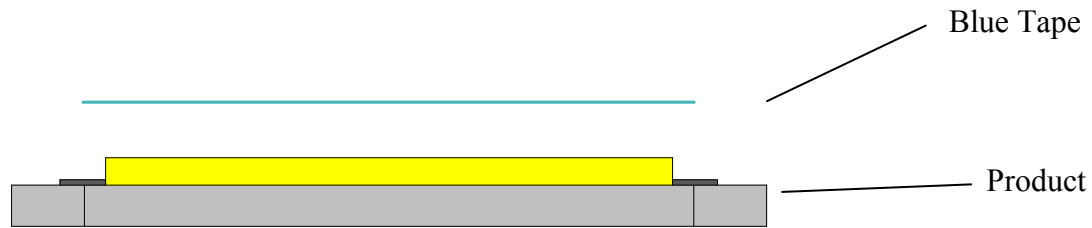



Under Development	●
Mass production	

Precaution for use 1

1、 Hand Soldering

Be careful because the damage of the product is often started at the time of the hand soldering.

Stress on the LEDs should be avoided during heating in soldering process.

After soldering, do not deal with the product before its temperature drop down to room temperature.

2、 Cleaning

It is recommended that alcohol be used as a solvent for cleaning after soldering. Cleaning is to go under 30°C for 3 minutes or 50°C for 30 seconds. When using other solvents, it should be confirmed beforehand whether the solvents will dissolve the package and the silicone or not.

Ultrasonic cleaning is also an effective way for cleaning. But the influence of Ultrasonic cleaning on LED depends on factors such as ultrasonic power. Generally, the ultrasonic power should not be higher than 300W. Before cleaning, a pre-test should be done to confirm whether any damage to LEDs will occur.

3、 Static Electricity

Static electricity or surge voltage damages the LEDs. Damaged LEDs will show some unusual characteristics such as the forward voltage becomes lower, or the LEDs do not light at the low current., even not light.

All devices, equipment and machinery must be properly grounded. At the same time, it is recommended that wrist bands or anti-electrostatic gloves, anti-electrostatic containers be used when dealing with the LEDs.

4、 Design Consideration

In designing a circuit, the current through each LED must not exceed the absolute maximum rating specified for each LED. In the meanwhile, resistors for protection should be applied, otherwise slight voltage shift will cause big current change, burn out may happen.

Thermal Design is paramount importance because heat generation may result in the Characteristics decline, such as brightness decreased, Color changed and so on. Please consider the heat generation of the LEDs when making the system design.

In the use of screws, you need to pay attention to LED damaged, need to be careful; installation, you can use clip-type to install, to avoid damage!



Under Development	●
Mass production	

Precaution for use 2

1.Storage

To avoid the moisture penetration ,we recommend storing LEDs in a dry box (or a desiccator) with a desiccant. The recommended conditions are temperature 5 to 30 degrees Centigrade. Humidity 60% maximum.

2.Precaution after opening packing

2.1.Soldering should be done right after opening the package (within 24Hrs).

2.2.Keeping of a fraction.

-Sealing

-Temperature: 5~30°C Humidity: less than 30%

2.3.If the package has been opened than 1 week or the color of desiccant changed, components should be dried for 10-12 Hrs at 60±5°C.

3.Any mechanical force or any excess vibration shall not be accepted to apply during cooling process to normal temperature after soldering.

4.Please avoid rapid cooling after soldering.

5.Components should not be mounted on warped direction of PCB.

6.This device should not be used in any fluid such as water, oil ,organic solvent etc. When washing is required, Isopropyl Alcohol should be used.

7.When the LEDs are illuminating, operating current should be decided after considering the package maximum temperature.

8.Avoid touching Lens parts especially by sharp tools such as pincette.

9.Please do not force over 1000g impact or pressure diagonally on the silicone lens. It will cause fatal damage on this product.

10.Please do not cover the silicone resin of the LEDs with other resin.

11.Do not use metal suction nozzle, rubber or silica gel suction nozzle is recommended.

12.Recommend that the area of the heat sink is larger than 50cm²/W (with thickness about 2 mm).

13.Viewing direct to the light emitting center of the LEDs, especially those of great Luminous Intensity, will cause great hazard to human eyes. Please be careful.

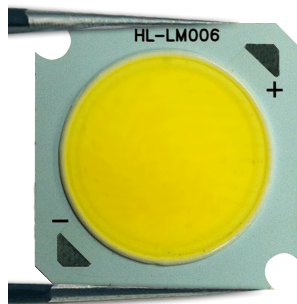

OK

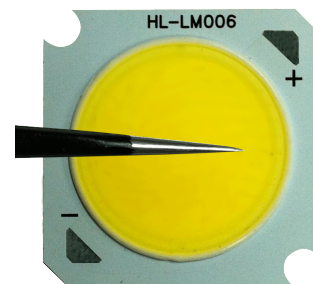

NG