

**OCTAL D-TYPE FLIP FLOP WITH 3 STATE OUTPUT**  
**HC564 INVERTING - HC574 NON INVERTING**

- HIGH SPEED  
f<sub>MAX</sub> = 62 MHz (TYP.) AT V<sub>CC</sub> = 5 V
- LOW POWER DISSIPATION  
I<sub>CC</sub> = 4 μA (MAX.) AT T<sub>A</sub> = 25 °C
- HIGH NOISE IMMUNITY  
V<sub>NIH</sub> = V<sub>NIL</sub> = 28% V<sub>CC</sub> (MIN)
- OUTPUT DRIVE CAPABILITY  
15 LSTTL LOADS
- SYMMETRICAL OUTPUT IMPEDANCE  
I<sub>OL</sub> = |I<sub>OH</sub>| = 6 mA (MIN.)
- BALANCED PROPAGATION DELAYS  
t<sub>PLH</sub> = t<sub>PHL</sub>
- WIDE OPERATING VOLTAGE RANGE  
V<sub>CC</sub> (OPR) = 2 V TO 6 V
- PIN AND FUNCTION COMPATIBLE  
WITH 54/74LS564/574

**DESCRIPTION**

The M54/74HC564 and M54HC574 are high speed CMOS OCTAL D-TYPE FLIP FLOP WITH 3-STATE OUTPUTS fabricated with in silicon gate C<sup>2</sup>MOS technology. They have the same high speed performance of LSTTL combined with true CMOS low power consumption. These 8-bit D-type flip-flops are controlled by a clock input (CK) and an output enable input ( $\overline{OE}$ ). On the positive transition of the clock, the Q outputs will be set to the logic state that were setup at the D inputs (HC574) or their complements (HC564).

While the  $\overline{OE}$  input is low, the eight outputs will be in a normal logic state (high or low logic level), and while high level, the outputs will be in a high imped-

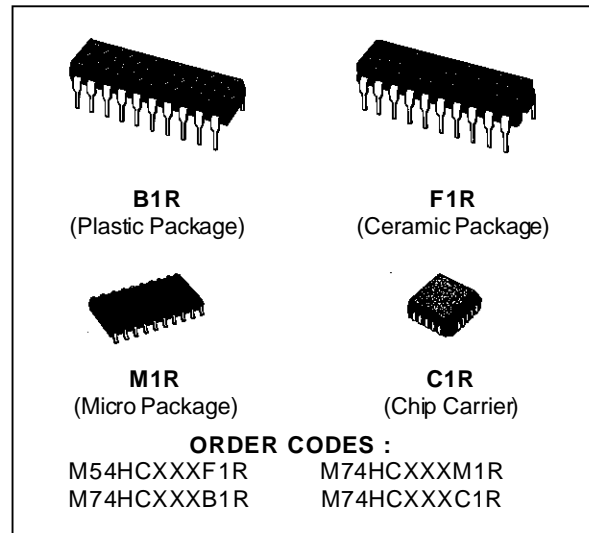

ance state. The output control does not affect the internal operation of flip-flops. That is, the old data can be retained or the new data can be entered even while the outputs are off. The application engineer has a choice of combination of inverting and non-inverting outputs. The 3-state output configuration and the wide choice of outline make bus-organized systems simple. All inputs are equipped with protection circuits against static discharge and transient excess voltage.

**PIN CONNECTION (top view)**

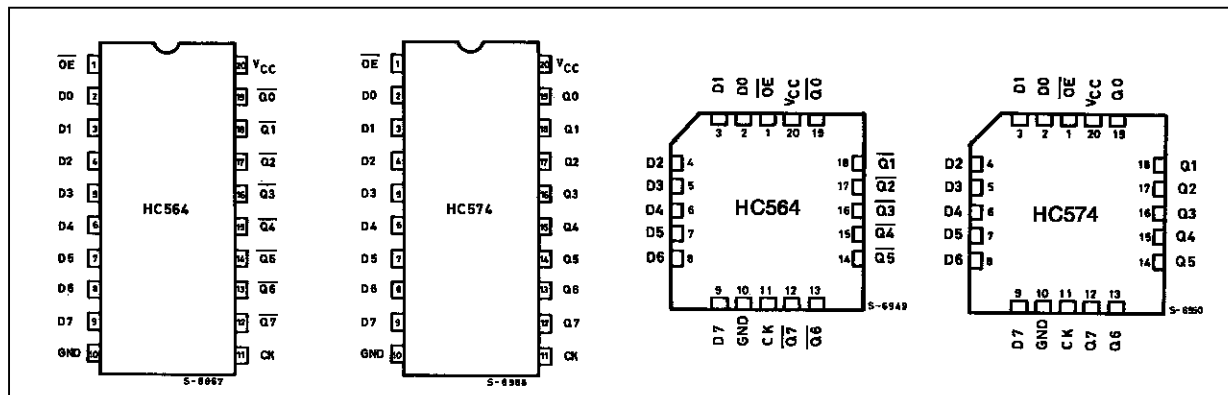

INPUT AND OUTPUT EQUIVALENT CIRCUIT



PIN DESCRIPTION (HC564)

PIN No	SYMBOL	NAME AND FUNCTION
1	$\overline{OE}$	3 State output Enable Input (Active LOW)
2, 3, 4, 5, 6, 7, 8, 9, 10	D0 to D7	Data Inputs
12, 13, 14, 15, 16, 17, 18, 19	$\overline{Q0}$ to $\overline{Q7}$	3 State outputs
11	CLOCK	Clock Input (LOW to HIGH, edge triggered)
10	GND	Ground (0V)
20	V <sub>CC</sub>	Positive Supply Voltage

PIN DESCRIPTION (HC574)

PIN No	SYMBOL	NAME AND FUNCTION
1	$\overline{OE}$	3 State output Enable Input (Active LOW)
2, 3, 4, 5, 6, 7, 8, 9, 10	D0 to D7	Data Inputs
12, 13, 14, 15, 16, 17, 18, 19	Q0 to Q7	3 State outputs
11	CLOCK	Clock Input (LOW to HIGH, edge triggered)
10	GND	Ground (0V)
20	V <sub>CC</sub>	Positive Supply Voltage

IEC LOGIC SYMBOLS

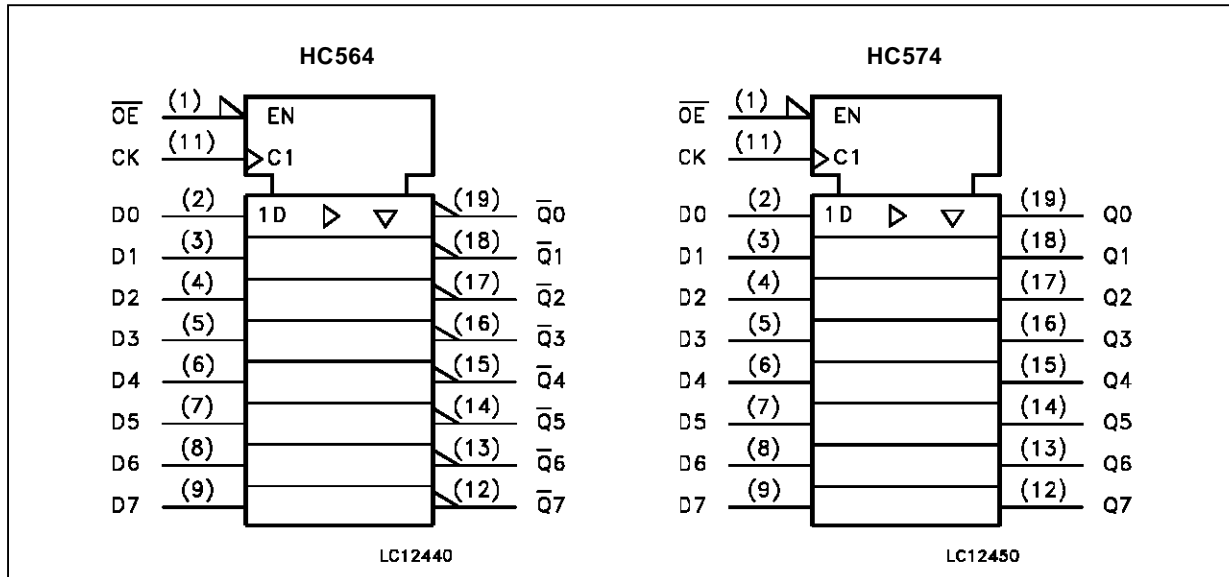

TRUTH TABLE

INPUTS			OUTPUTS	
OE	CK	D	Q (HC574)	$\bar{Q}$ (HC564)
H	X	X	Z	Z
L	$\downarrow$	X	NO CHANGE	NO CHANGE
L	$\uparrow$	L	L	H
L	$\uparrow$	H	H	L

LOGIC DIAGRAMS

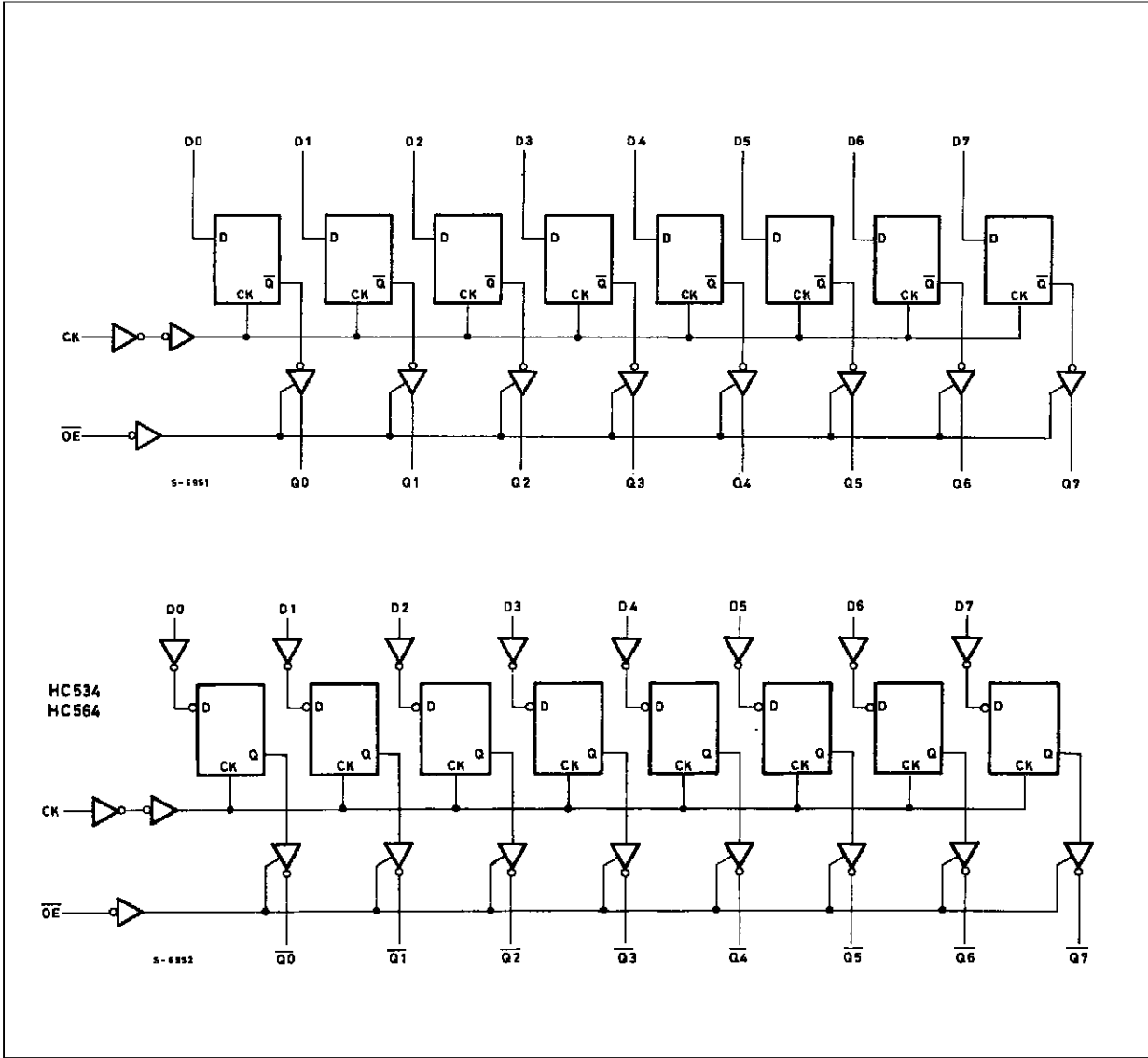

**ABSOLUTE MAXIMUM RATINGS**

Symbol	Parameter	Value	Unit
V <sub>CC</sub>	Supply Voltage	-0.5 to +7	V
V <sub>I</sub>	DC Input Voltage	-0.5 to V <sub>CC</sub> + 0.5	V
V <sub>O</sub>	DC Output Voltage	-0.5 to V <sub>CC</sub> + 0.5	V
I <sub>IK</sub>	DC Input Diode Current	± 20	mA
I <sub>OK</sub>	DC Output Diode Current	± 20	mA
I <sub>O</sub>	DC Output Source Sink Current Per Output Pin	± 35	mA
I <sub>CC</sub> or I <sub>GND</sub>	DC V <sub>CC</sub> or Ground Current	± 70	mA
P <sub>D</sub>	Power Dissipation	500 (*)	mW
T <sub>stg</sub>	Storage Temperature	-65 to +150	°C
T <sub>L</sub>	Lead Temperature (10 sec)	300	°C

Absolute Maximum Ratings are those values beyond which damage to the device may occur. Functional operation under these condition is not implied.

(\*) 500 mW: ≡ 65 °C derate to 300 mW by 10mW/°C: 65 °C to 85 °C

**RECOMMENDED OPERATING CONDITIONS**

Symbol	Parameter	Value	Unit
V <sub>CC</sub>	Supply Voltage	2 to 6	V
V <sub>I</sub>	Input Voltage	0 to V <sub>CC</sub>	V
V <sub>O</sub>	Output Voltage	0 to V <sub>CC</sub>	V
T <sub>op</sub>	Operating Temperature: <b>M54HC Series</b>	-55 to +125	°C
	<b>M74HC Series</b>	-40 to +85	°C
t <sub>r</sub> , t <sub>f</sub>	Input Rise and Fall Time	V <sub>CC</sub> = 2 V	0 to 1000
		V <sub>CC</sub> = 4.5 V	0 to 500
		V <sub>CC</sub> = 6 V	0 to 400

## DC SPECIFICATIONS

Symbol	Parameter	Test Conditions		Value						Unit		
		V <sub>CC</sub> (V)		T <sub>A</sub> = 25 °C 54HC and 74HC			-40 to 85 °C 74HC		-55 to 125 °C 54HC			
				Min.	Typ.	Max.	Min.	Max.	Min.		Max.	
V <sub>IH</sub>	High Level Input Voltage	2.0		1.5			1.5		1.5		V	
		4.5		3.15			3.15		3.15			
		6.0		4.2			4.2		4.2			
V <sub>IL</sub>	Low Level Input Voltage	2.0				0.5		0.5		0.5	V	
		4.5				1.35		1.35		1.35		
		6.0				1.8		1.8		1.8		
V <sub>OH</sub>	High Level Output Voltage	2.0	V <sub>I</sub> = V <sub>IH</sub> or V <sub>IL</sub>	I <sub>O</sub> = -20 μA	1.9	2.0		1.9		1.9	V	
		4.5			4.4	4.5		4.4		4.4		
		6.0			5.9	6.0		5.9		5.9		
		4.5	I <sub>O</sub> = -6.0 mA	4.18	4.31		4.13		4.10			
		6.0		I <sub>O</sub> = -7.8 mA	5.68	5.8		5.63		5.60		
V <sub>OL</sub>	Low Level Output Voltage	2.0	V <sub>I</sub> = V <sub>IH</sub> or V <sub>IL</sub>	I <sub>O</sub> = 20 μA		0.0	0.1		0.1		0.1	V
		4.5				0.0	0.1		0.1		0.1	
		6.0				0.0	0.1		0.1		0.1	
		4.5		I <sub>O</sub> = 6.0 mA		0.17	0.26		0.33		0.40	
		6.0			I <sub>O</sub> = 7.8 mA		0.18	0.26		0.33		
I <sub>I</sub>	Input Leakage Current	6.0	V <sub>I</sub> = V <sub>CC</sub> or GND			±0.1		±1		±1	μA	
I <sub>OZ</sub>	3 State Output Off State Current	6.0	V <sub>I</sub> = V <sub>IH</sub> or V <sub>IL</sub> V <sub>O</sub> = V <sub>CC</sub> or GND			±0.5		±5.0		±10	μA	
I <sub>CC</sub>	Quiescent Supply Current	6.0	V <sub>I</sub> = V <sub>CC</sub> or GND			4		40		80	μA	

AC ELECTRICAL CHARACTERISTICS (C<sub>L</sub> = 50 pF, Input t<sub>r</sub> = t<sub>f</sub> = 6 ns)

Symbol	Parameter	Test Conditions			Value						Unit	
		V <sub>CC</sub> (V)	C <sub>L</sub> (pF)		T <sub>A</sub> = 25 °C 54HC and 74HC			-40 to 85 °C 74HC		-55 to 125 °C 54HC		
					Min.	Typ.	Max.	Min.	Max.	Min.		Max.
t <sub>TLH</sub> t <sub>THL</sub>	Output Transition Time	2.0	50			25	60		75		90	ns
		4.5				7	12		15		18	
		6.0				6	10		13		15	
t <sub>PLH</sub> t <sub>PHL</sub>	Propagation Delay Time (CLOCK - Q, $\bar{Q}$ )	2.0	50			70	150		190		225	ns
		4.5				20	30		38		45	
		6.0				15	26		32		38	
		2.0	150			88	190		240		285	ns
		4.5				25	38		48		57	
		6.0				19	32		41		48	
t <sub>PZL</sub> t <sub>PZH</sub>	3 State Output Enable Time	2.0	50	R <sub>L</sub> = 1 KΩ		48	125		155		190	ns
		4.5				15	25		31		38	
		6.0				12	21		26		32	
		2.0	150	R <sub>L</sub> = 1 KΩ		60	165		205		250	ns
		4.5				20	33		41		50	
		6.0				16	28		35		43	
t <sub>PLZ</sub> t <sub>PHZ</sub>	3 State Output Disable Time	2.0	50	R <sub>L</sub> = 1 KΩ		34	125		155		190	ns
		4.5				17	25		31		38	
		6.0				15	21		26		32	
f <sub>MAX</sub>	Maximum CLock Frequency	2.0	50		6.2	18		5		4.2		ns
		4.5			31	75		25		21		
		6.0			37	90		30		25		
t <sub>w(L)</sub> t <sub>w(H)</sub>	Minimum Pulse Width (CLOCK)	2.0	50			15	75		95		110	ns
		4.5				6	15		19		22	
		6.0				6	13		16		19	
t <sub>s</sub>	Minimum Set-up Time	2.0	50			25	75		95		110	ns
		4.5				6	15		19		22	
		6.0				4	13		16		19	
t <sub>h</sub>	Minimum Hold Time	2.0	50				0		0		0	ns
		4.5					0		0		0	
		6.0					0		0		0	
C <sub>IN</sub>	Input Capacitance					5	10		10		10	pF
C <sub>OUT</sub>	Out put Capacitance					10						pF
C <sub>PD</sub> (*)	Power Dissipation Capacitance					54						pF

(\*) C<sub>PD</sub> is defined as the value of the IC's internal equivalent capacitance which is calculated from the operating current consumption without load. (Refer to Test Circuit). Average operating current can be obtained by the following equation. I<sub>CC(OPR)</sub> = C<sub>PD</sub> • V<sub>CC</sub> • f<sub>IN</sub> + I<sub>CC</sub>

SWITCHING CHARACTERISTICS TEST WAVEFORM

$t_{PLH}$ ,  $t_{PHL}$ ,  $t_s$ ,  $t_h$ ,  $t_w$

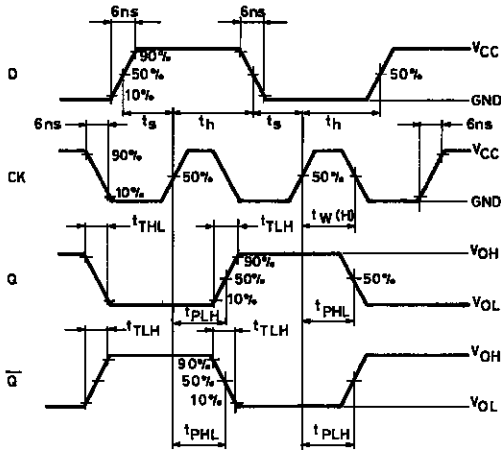

S-10450

$f_{MAX}$

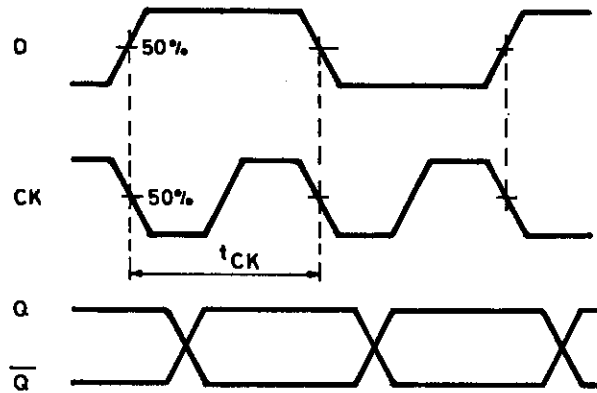

S-10451

$t_{PLZ}$ ,  $t_{PZL}$

The 1KΩ load resistors should be connected between outputs and V<sub>CC</sub> line and the 50pF load capacitors should be connected between outputs and GND line. All inputs except  $\overline{OE}$  input should be connected to V<sub>CC</sub> line or GND line such that outputs will be in low logic level while  $\overline{OE}$  input is held low.

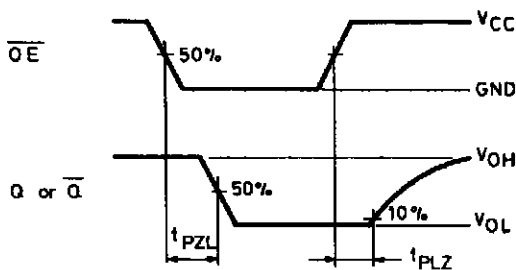

S-10429

$t_{PHZ}$ ,  $t_{PZH}$

The 1KΩ load resistors and the 50pF load capacitors should be connected between each output and GND line. All inputs except  $\overline{OE}$  input should be connected to V<sub>CC</sub> or GND line such that output will be in high logic level while  $\overline{OE}$  input is held low.

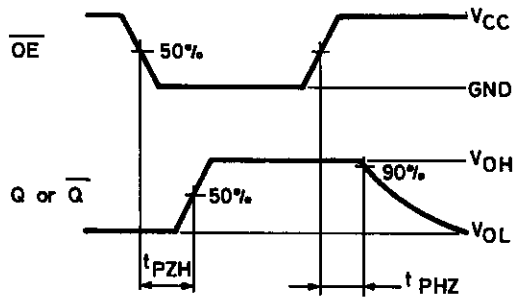

S-10430

## M54/M74HC564/574

### TEST CIRCUIT $I_{CC}$ (Opr.)





## Plastic DIP20 (0.25) MECHANICAL DATA

DIM.	mm			inch		
	MIN.	TYP.	MAX.	MIN.	TYP.	MAX.
a1	0.254			0.010		
B	1.39		1.65	0.055		0.065
b		0.45			0.018	
b1		0.25			0.010	
D			25.4			1.000
E		8.5			0.335	
e		2.54			0.100	
e3		22.86			0.900	
F			7.1			0.280
I			3.93			0.155
L		3.3			0.130	
Z			1.34			0.053



Ceramic DIP20 MECHANICAL DATA

DIM.	mm			inch		
	MIN.	TYP.	MAX.	MIN.	TYP.	MAX.
A			25			0.984
B			7.8			0.307
D		3.3			0.130	
E	0.5		1.78	0.020		0.070
e3		22.86			0.900	
F	2.29		2.79	0.090		0.110
G	0.4		0.55	0.016		0.022
I	1.27		1.52	0.050		0.060
L	0.22		0.31	0.009		0.012
M	0.51		1.27	0.020		0.050
N1	4° (min.), 15° (max.)					
P	7.9		8.13	0.311		0.320
Q			5.71			0.225



## SO20 MECHANICAL DATA

DIM.	mm			inch		
	MIN.	TYP.	MAX.	MIN.	TYP.	MAX.
A			2.65			0.104
a1	0.10		0.20	0.004		0.007
a2			2.45			0.096
b	0.35		0.49	0.013		0.019
b1	0.23		0.32	0.009		0.012
C		0.50			0.020	
c1	45° (typ.)					
D	12.60		13.00	0.496		0.512
E	10.00		10.65	0.393		0.419
e		1.27			0.050	
e3		11.43			0.450	
F	7.40		7.60	0.291		0.299
L	0.50		1.27	0.19		0.050
M			0.75			0.029
S	8° (max.)					



P013L

PLCC20 MECHANICAL DATA

DIM.	mm			inch		
	MIN.	TYP.	MAX.	MIN.	TYP.	MAX.
A	9.78		10.03	0.385		0.395
B	8.89		9.04	0.350		0.356
D	4.2		4.57	0.165		0.180
d1		2.54			0.100	
d2		0.56			0.022	
E	7.37		8.38	0.290		0.330
e		1.27			0.050	
e3		5.08			0.200	
F		0.38			0.015	
G			0.101			0.004
M		1.27			0.050	
M1		1.14			0.045	



Information furnished is believed to be accurate and reliable. However, SGS-THOMSON Microelectronics assumes no responsibility for the consequences of use of such information nor for any infringement of patents or other rights of third parties which may result from its use. No license is granted by implication or otherwise under any patent or patent rights of SGS-THOMSON Microelectronics. Specifications mentioned in this publication are subject to change without notice. This publication supersedes and replaces all information previously supplied. SGS-THOMSON Microelectronics products are not authorized for use as critical components in life support devices or systems without express written approval of SGS-THOMSON Microelectronics.

© 1994 SGS-THOMSON Microelectronics - All Rights Reserved

SGS-THOMSON Microelectronics GROUP OF COMPANIES

Australia - Brazil - France - Germany - Hong Kong - Italy - Japan - Korea - Malaysia - Malta - Morocco - The Netherlands -  
Singapore - Spain - Sweden - Switzerland - Taiwan - Thailand - United Kingdom - U.S.A