

Silicon Power Transistors

The MJL21193 and MJL21194 utilize Perforated Emitter technology and are specifically designed for high power audio output, disk head positioners and linear applications.

- Total Harmonic Distortion Characterized
- High DC Current Gain – $h_{FE} = 25$ Min @ $I_C = 8$ Adc
- Excellent Gain Linearity
- High SOA: 2.25 A, 80 V, 1 Second

PNP
MJL21193*
NPN
MJL21194*

*Motorola Preferred Device

16 AMPERE
COMPLEMENTARY
SILICON POWER
TRANSISTORS
250 VOLTS
200 WATTS

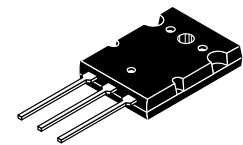

CASE 340G-02
TO-3PBL

MAXIMUM RATINGS

| Rating | Symbol | Value | Unit |
|---|----------------|-------------|------------------------------|
| Collector-Emitter Voltage | V_{CEO} | 250 | Vdc |
| Collector-Base Voltage | V_{CBO} | 400 | Vdc |
| Emitter-Base Voltage | V_{EBO} | 5 | Vdc |
| Collector-Emitter Voltage – 1.5 V | V_{CEX} | 400 | Vdc |
| Collector Current — Continuous Peak (1) | I_C | 16 30 | Adc |
| Base Current – Continuous | I_B | 5 | Adc |
| Total Power Dissipation @ $T_C = 25^\circ\text{C}$ Derate Above 25°C | P_D | 200 1.43 | Watts W/ $^\circ\text{C}$ |
| Operating and Storage Junction Temperature Range | T_J, T_{stg} | -65 to +150 | $^\circ\text{C}$ |

THERMAL CHARACTERISTICS

| Characteristic | Symbol | Max | Unit |
|--------------------------------------|-----------------|-----|--------------------|
| Thermal Resistance, Junction to Case | $R_{\theta JC}$ | 0.7 | $^\circ\text{C/W}$ |

ELECTRICAL CHARACTERISTICS ($T_C = 25^\circ\text{C}$ unless otherwise noted)

| Characteristic | Symbol | Min | Typical | Max | Unit |
|----------------|--------|-----|---------|-----|------|
|----------------|--------|-----|---------|-----|------|

OFF CHARACTERISTICS

| | | | | | |
|---|----------------|-----|---|-----|-----------------|
| Collector-Emitter Sustaining Voltage ($I_C = 100$ mAdc, $I_B = 0$) | $V_{CEO(sus)}$ | 250 | — | — | Vdc |
| Collector Cutoff Current ($V_{CE} = 200$ Vdc, $I_B = 0$) | I_{CEO} | — | — | 100 | μAdc |

(1) Pulse Test: Pulse Width = 5.0 μs , Duty Cycle $\leq 10\%$.

(continued)

Preferred devices are Motorola recommended choices for future use and best overall value.

MJL21193 MJL21194

ELECTRICAL CHARACTERISTICS ($T_C = 25^\circ\text{C}$ unless otherwise noted)

| Characteristic | Symbol | Min | Typical | Max | Unit |
|---|----------------------|-------------|-------------|----------|-----------------|
| OFF CHARACTERISTICS | | | | | |
| Emitter Cutoff Current ($V_{CE} = 5\text{ Vdc}$, $I_C = 0$) | I_{EBO} | — | — | 100 | μAdc |
| Collector Cutoff Current ($V_{CE} = 250\text{ Vdc}$, $V_{BE(\text{off})} = 1.5\text{ Vdc}$) | I_{CEX} | — | — | 100 | μAdc |
| SECOND BREAKDOWN | | | | | |
| Second Breakdown Collector Current with Base Forward Biased ($V_{CE} = 50\text{ Vdc}$, $t = 1\text{ s}$ (non-repetitive)) ($V_{CE} = 80\text{ Vdc}$, $t = 1\text{ s}$ (non-repetitive)) | $I_{S/b}$ | 4.0 2.25 | — — | — — | A _{dc} |
| ON CHARACTERISTICS | | | | | |
| DC Current Gain ($I_C = 8\text{ Adc}$, $V_{CE} = 5\text{ Vdc}$) ($I_C = 16\text{ Adc}$, $I_B = 5\text{ Adc}$) | h_{FE} | 25 8 | — — | 75 — | |
| Base-Emitter On Voltage ($I_C = 8\text{ Adc}$, $V_{CE} = 5\text{ Vdc}$) | $V_{BE(\text{on})}$ | — | — | 2.2 | V _{dc} |
| Collector-Emitter Saturation Voltage ($I_C = 8\text{ Adc}$, $I_B = 0.8\text{ Adc}$) ($I_C = 16\text{ Adc}$, $I_B = 3.2\text{ Adc}$) | $V_{CE(\text{sat})}$ | — — | — — | 1.4 4 | V _{dc} |
| DYNAMIC CHARACTERISTICS | | | | | |
| Total Harmonic Distortion at the Output $V_{RMS} = 28.3\text{ V}$, $f = 1\text{ kHz}$, $P_{LOAD} = 100\text{ W}_{RMS}$ (Matched pair $h_{FE} = 50 @ 5\text{ A}/5\text{ V}$) | T_{HD} | — | 0.8 0.08 | — | % |
| Current Gain Bandwidth Product ($I_C = 1\text{ Adc}$, $V_{CE} = 10\text{ Vdc}$, $f_{\text{test}} = 1\text{ MHz}$) | f_T | 4 | — | — | MHz |
| Output Capacitance ($V_{CB} = 10\text{ Vdc}$, $I_E = 0$, $f_{\text{test}} = 1\text{ MHz}$) | C_{ob} | — | — | 500 | pF |

(1) Pulse Test: Pulse Width = 300 μs , Duty Cycle $\leq 2\%$

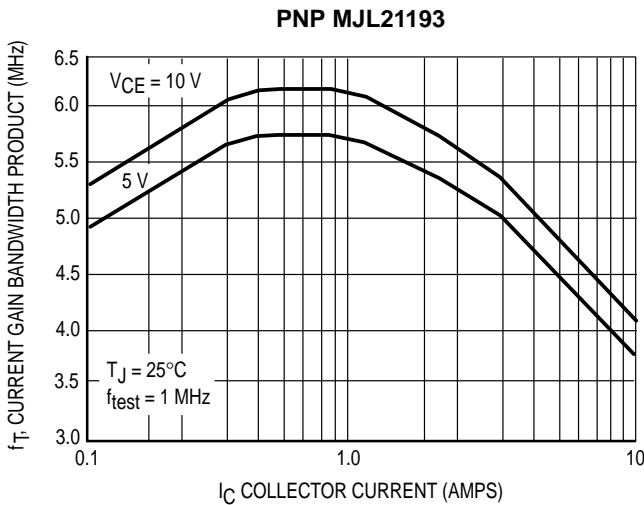

Figure 1. Typical Current Gain Bandwidth Product

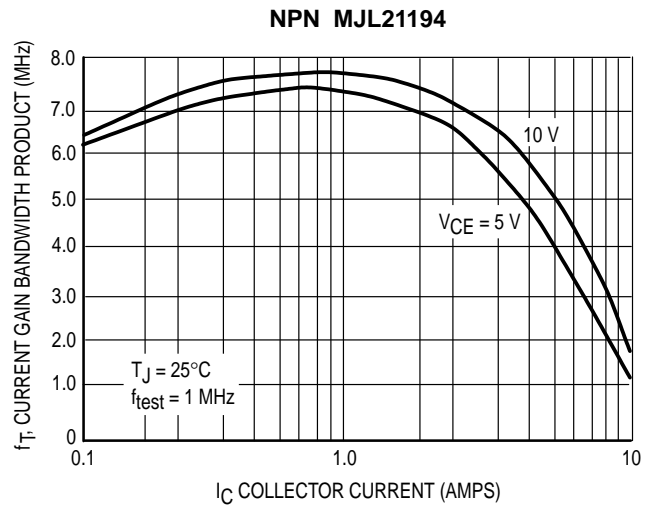

Figure 2. Typical Current Gain Bandwidth Product

TYPICAL CHARACTERISTICS

PNP MJL21193

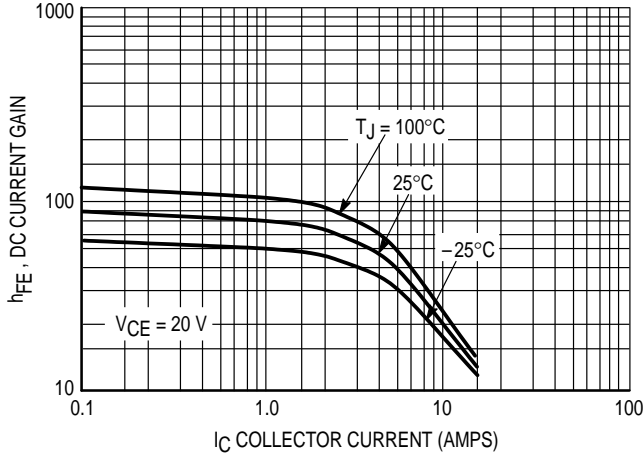

Figure 3. DC Current Gain, $V_{CE} = 20\text{ V}$

NPN MJL21194

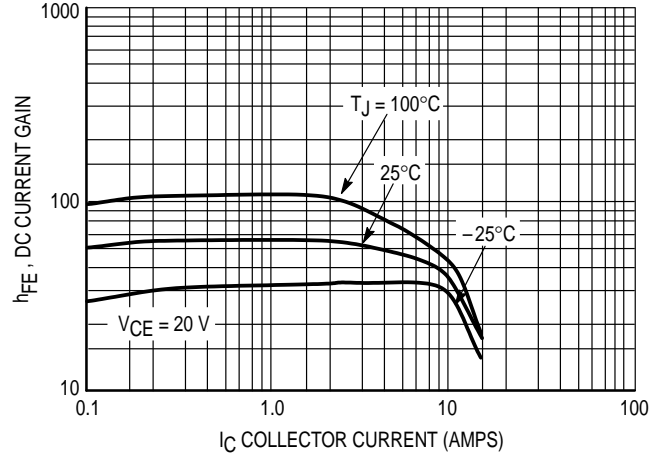

Figure 4. DC Current Gain, $V_{CE} = 20\text{ V}$

PNP MJL21193

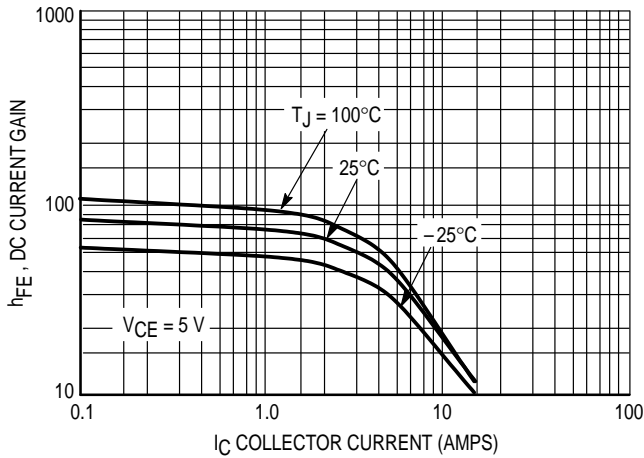

Figure 5. DC Current Gain, $V_{CE} = 5\text{ V}$

NPN MJL21194

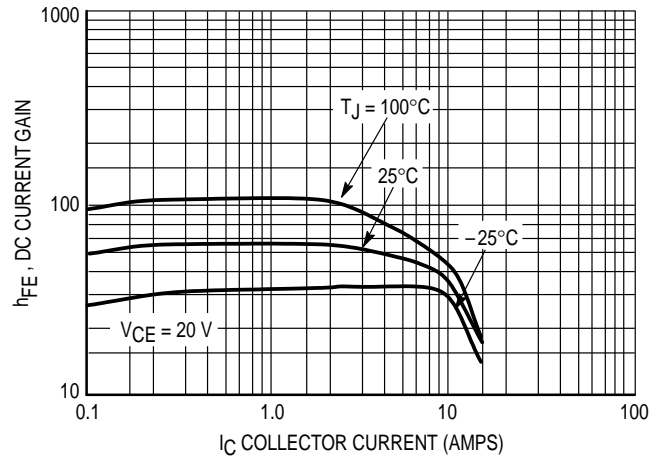

Figure 6. DC Current Gain, $V_{CE} = 5\text{ V}$

PNP MJL21193

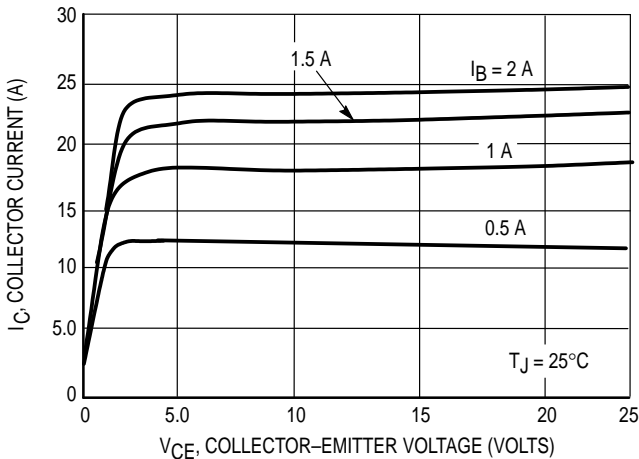

Figure 7. Typical Output Characteristics

NPN MJL21194

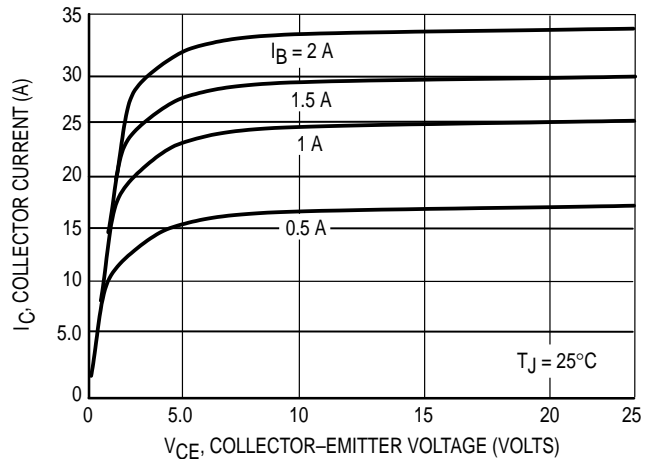

Figure 8. Typical Output Characteristics

TYPICAL CHARACTERISTICS

PNP MJL21193

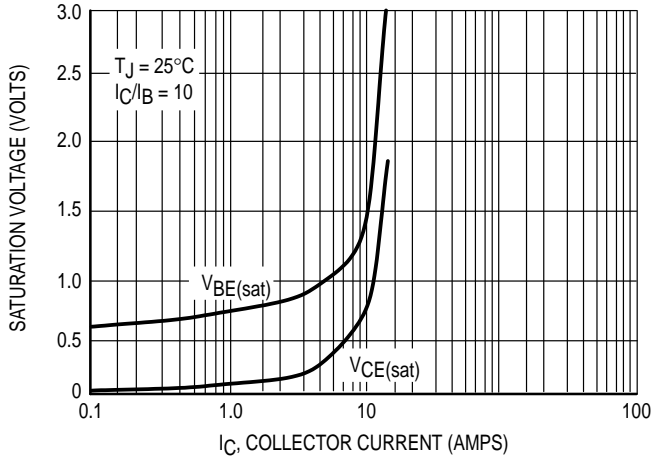

Figure 9. Typical Saturation Voltages

NPN MJL21194

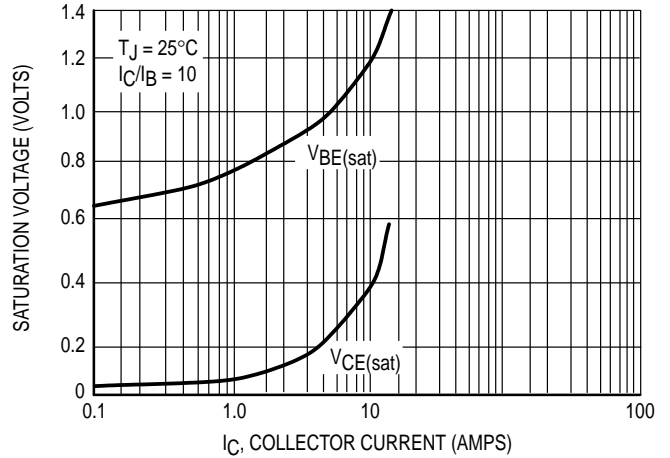

Figure 10. Typical Saturation Voltages

PNP MJL21193

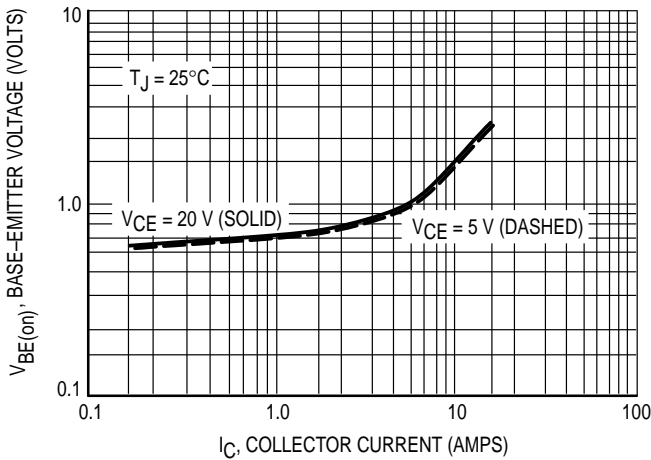

Figure 11. Typical Base-Emitter Voltage

NPN MJL21194

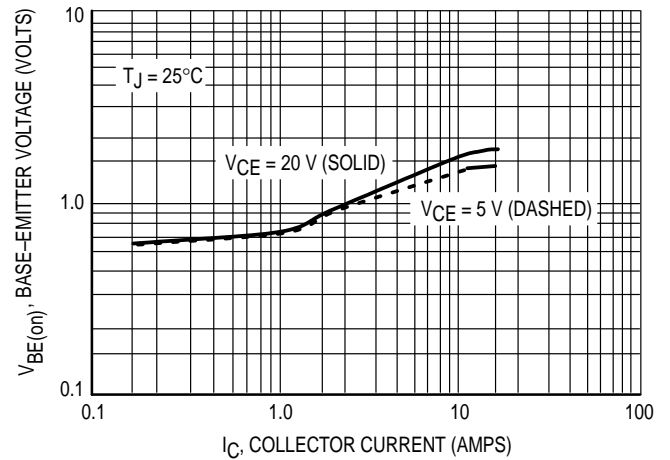

Figure 12. Typical Base-Emitter Voltage

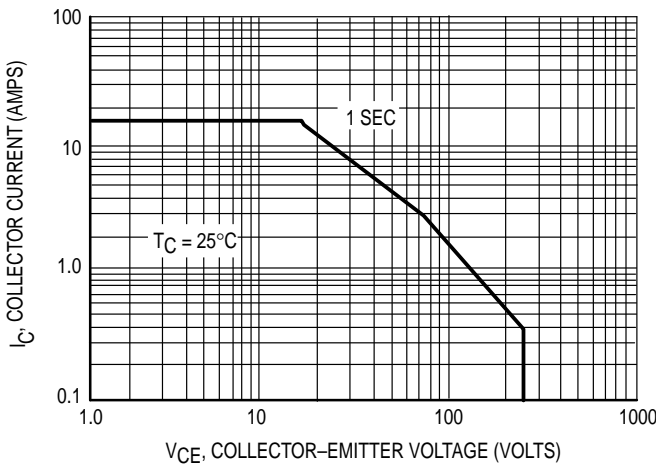

Figure 13. Active Region Safe Operating Area

There are two limitations on the power handling ability of a transistor; average junction temperature and secondary breakdown. Safe operating area curves indicate $I_C - V_{CE}$ limits of the transistor that must be observed for reliable operation; i.e., the transistor must not be subjected to greater dissipation than the curves indicate.

The data of Figure 13 is based on $T_{J(pk)} = 200^\circ\text{C}$; T_C is variable depending on conditions. At high case temperatures, thermal limitations will reduce the power than can be handled to values less than the limitations imposed by second breakdown.

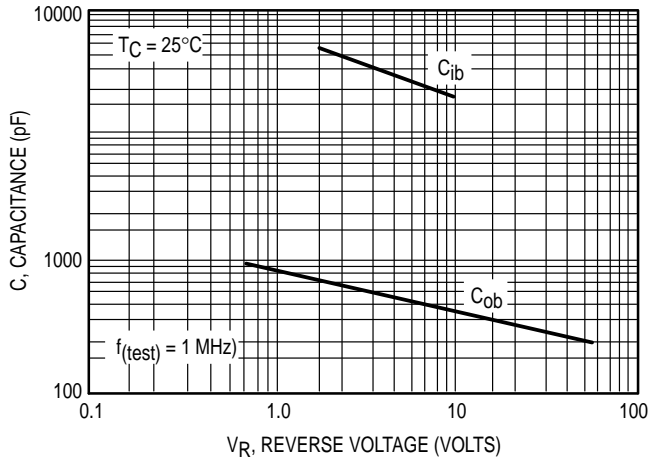

Figure 14. MJL21193 Typical Capacitance

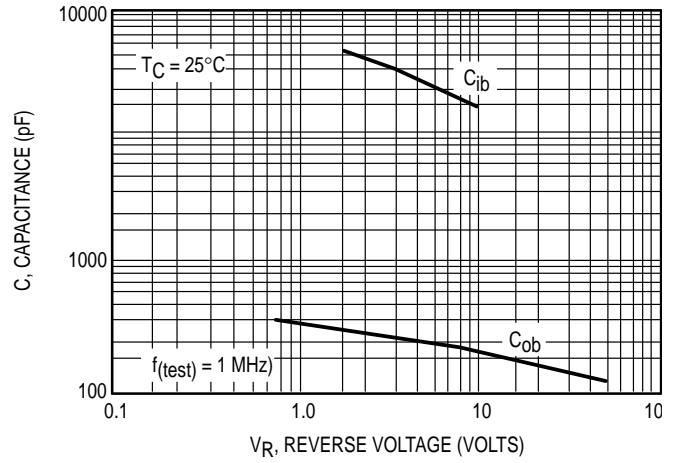

Figure 15. MJL21194 Typical Capacitance

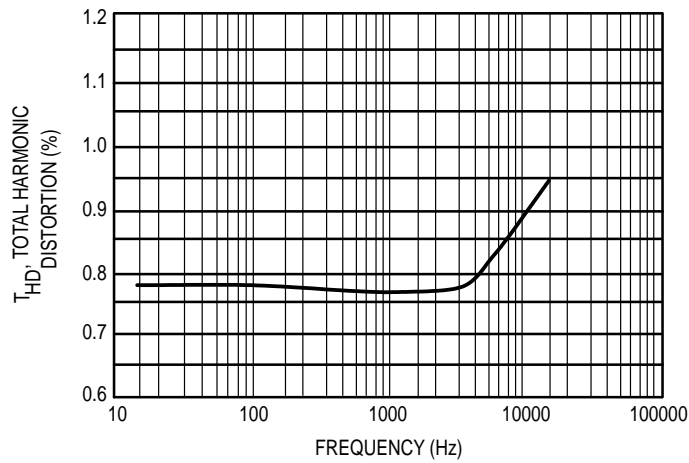

Figure 16. Typical Total Harmonic Distortion

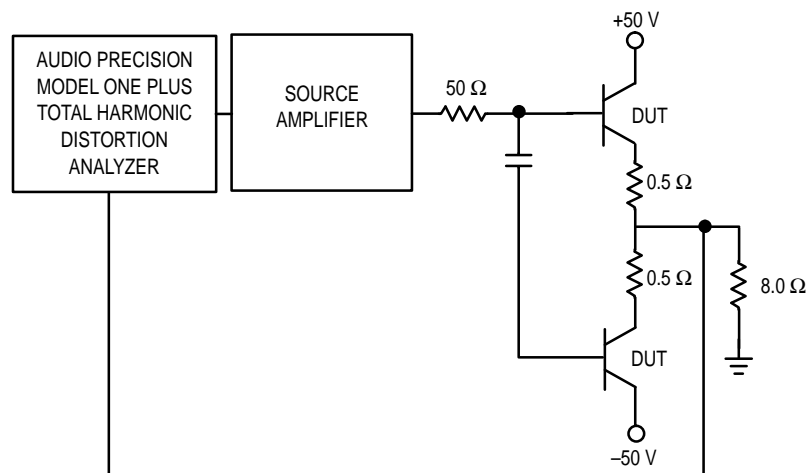
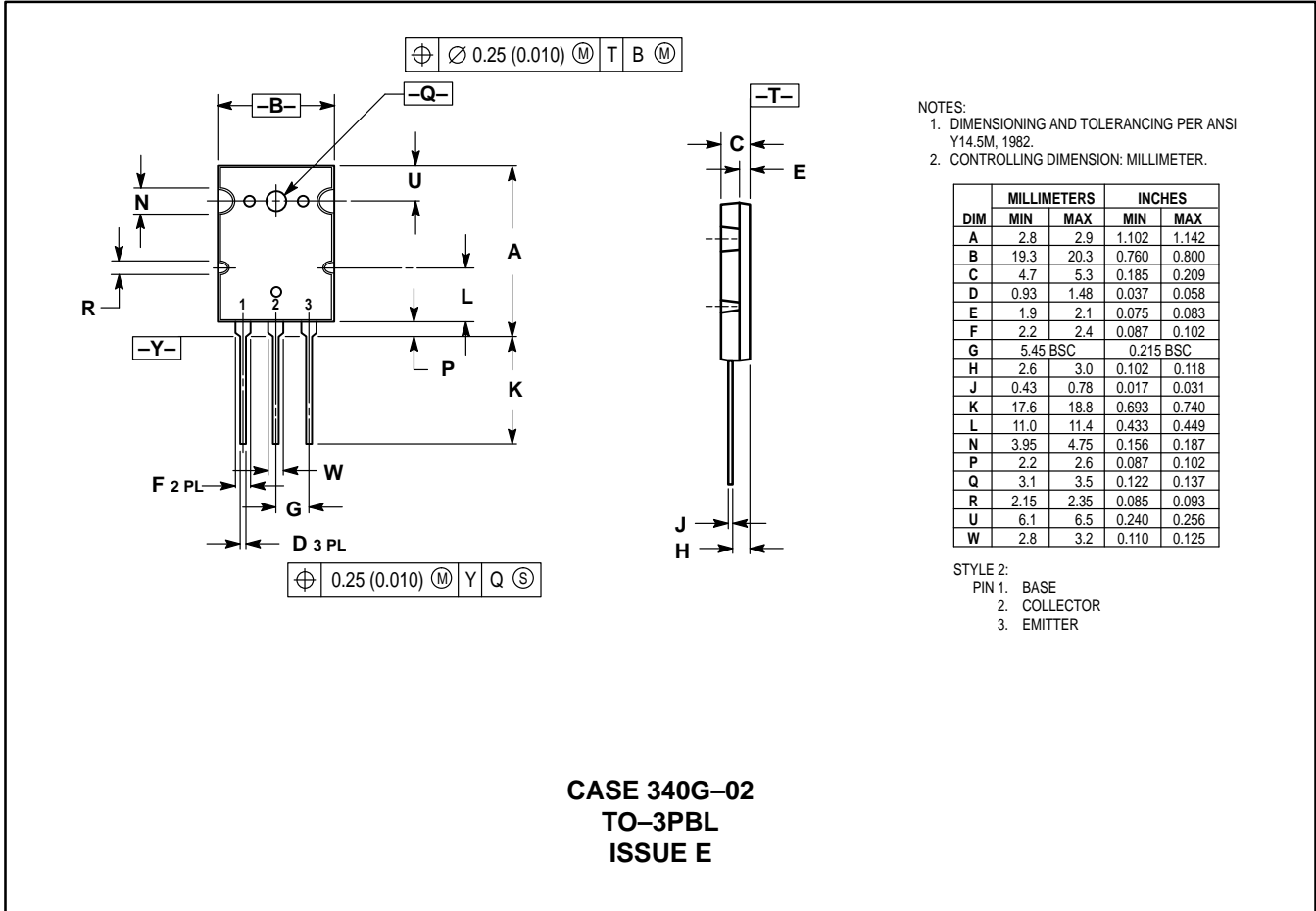

Figure 17. Total Harmonic Distortion Test Circuit

PACKAGE DIMENSIONS



Motorola reserves the right to make changes without further notice to any products herein. Motorola makes no warranty, representation or guarantee regarding the suitability of its products for any particular purpose, nor does Motorola assume any liability arising out of the application or use of any product or circuit, and specifically disclaims any and all liability, including without limitation consequential or incidental damages. "Typical" parameters can and do vary in different applications. All operating parameters, including "Typicals" must be validated for each customer application by customer's technical experts. Motorola does not convey any license under its patent rights nor the rights of others. Motorola products are not designed, intended, or authorized for use as components in systems intended for surgical implant into the body, or other applications intended to support or sustain life, or for any other application in which the failure of the Motorola product could create a situation where personal injury or death may occur. Should Buyer purchase or use Motorola products for any such unintended or unauthorized application, Buyer shall indemnify and hold Motorola and its officers, employees, subsidiaries, affiliates, and distributors harmless against all claims, costs, damages, and expenses, and reasonable attorney fees arising out of, directly or indirectly, any claim of personal injury or death associated with such unintended or unauthorized use, even if such claim alleges that Motorola was negligent regarding the design or manufacture of the part. Motorola and are registered trademarks of Motorola, Inc. Motorola, Inc. is an Equal Opportunity/Affirmative Action Employer.

How to reach us:
USA / EUROPE: Motorola Literature Distribution;
 P.O. Box 20912; Phoenix, Arizona 85036. 1-800-441-2447

JAPAN: Nippon Motorola Ltd.; Tatsumi-SPD-JLDC, Toshikatsu Otsuki,
 6F Seibu-Butsuryu-Center, 3-14-2 Tatsumi Koto-Ku, Tokyo 135, Japan. 03-3521-8315

MFAX: RMFAX0@email.sps.mot.com - TOUCHTONE (602) 244-6609
INTERNET: http://Design-NET.com

HONG KONG: Motorola Semiconductors H.K. Ltd.; 8B Tai Ping Industrial Park,
 51 Ting Kok Road, Tai Po, N.T., Hong Kong. 852-26629298

