

PTC THERMISTOR

FEATURES

- * High ageing coefficient
- * Superior withstanding voltage oxidation-resistance

CHARACTERISTICS

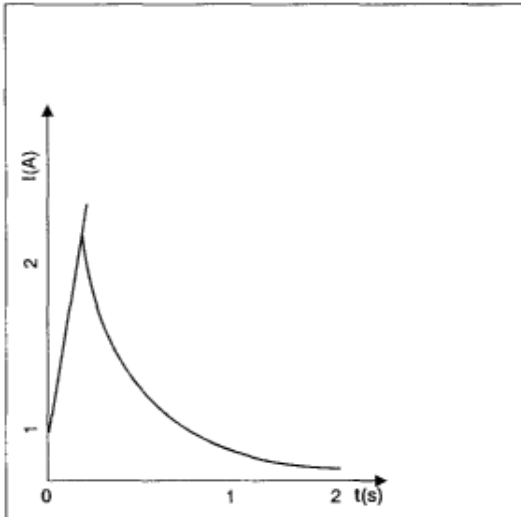

Current-Time Curve

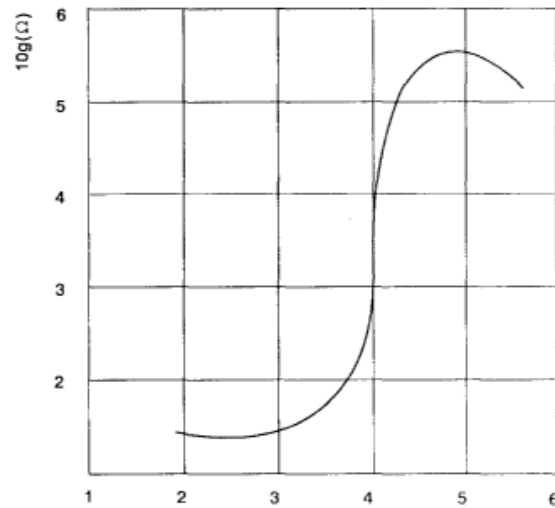

Resistance-Temperature Curve

HOW TO ORDER

MZ 2 1 L 201 R M
 ① ② ③ ④ ⑤ ⑥ ⑦

①
 PTC
 Thermistor

② Product style	
7	Degaussing
9	P~ Starter
2	Current-Limited
3	Delay-Time
4	Auto-Control-heat

③ Sequence No.	
MZ7	The number expresses No. of pin
MZ2	1.Coating type
MZ9	2.Plastic type
	3.Empty body
MZ3	No mark
MZ4	1. Round
	2. Queue

④ switch Temperature	
L	40°C
K	60°C
M	80°C
N	100°C
P	120°C
R	135°C

⑤ Resistance Value
 201=20x10
 8R0=8.0

⑥ OHM		⑦ Tolerance	
		K	± 10%
		M	± 20%
		N	± 30%

MZ9 TYPE Starter PTC THERMISTOR

FEATURES

- *As a non-touched switch in cold compressor and motor.
- *High reliability life etc.

APPLICATON ENVIROMENTAL CONDITIONS

- *Envionmental tepmerature: -20°C~ +85°C
- *Relative humidity: 98%(+40°C± 2°C)
- *Vibration frequency: 10~55Hz
- *Acceleration: 98m/s²

DIMENSIONS



MAIN TECHNICAL PARAMETER

Part No	Switch Temperature(°C)	Resistance Value(O)	Resistance Tolerance	Max Voltage(v)	Max Power(W)	Max Current(A)	Time to Tip(S)	Recover Time(S)
MZ92-P220RM	120	22	~20%	300	3.5	7.0	0.35-2.0	≤120
MZ92-P330RM	120	33	±20%	300	3.5	7.0	0.35-2.0	≤120
MZ92-P470RM	120	47	±20%	300	3.5	7.0	0.35-2.0	≤120
MZ92-R220RM	135	22	±20%	355	3.3	6.0	0.4-2.0	≤65
M7.92-R330RM	135	33	±20%	355	3.3	6.0	0.4-2.0	≤85
MZ92-N101RM	100	100	±20%	270	2.0	2.5	1.2-3.0	≤180
MZ93-2220AM	120	22	+20%	300	3.0	7.0	0.4-2.0	≤90
MZ93-P330RM	120	33	±20%	355	3.5	6.0	0.45-1.35	≤65
MZ93-P470RM	120	47	±20%	400	4.0	5.0	0.5-1.4	≤65
MZ93-R220RM	135	22	±20%	300	3.0	7.0	0.4-1.2	≤90
MZ93R330RM	135	33	±20%	355	3.5	6.0	0.45-1.35	≤65
MZ93-R470RM	135	47	±20%	400	4.0	5.0	0.5-1.4	≤65

Application Circuit

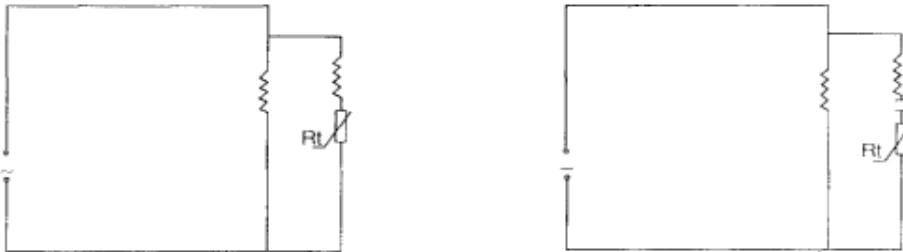

MZ3 TYPE PTC THERMISTOR for Delay-Time

FEATURES

Delay life and energy-saving is available for electronic light and ballast.
 One of restricting current unite in digital multimeter

APPLICATION ENVIROMENTAL CONDITIONS

Environmental temperature: $-10^{\circ}\text{C}\sim+125^{\circ}\text{C}$
 Relative humidity: $93\%(+40^{\circ}\text{C}\pm 2^{\circ}\text{C})$
 Vibration frequency: $10\sim 55\text{Hz}$
 Acceleration: 98m/s^2



DIMENSIONS

Part No.	D	T	L	W	d
	Max	Max	Max	± 0.5	± 0.1
MZ3-L100RN	8	45	35	5	0.55
MZ3-K100RN	8	4.6	35	5	0.55
MZ3-M100RN	10	5.5	35	5	0.55
MZ3-N100RN	10	5.5	35	5	0.55
MZ3-P100RN	10	5.5	35	5	0.55

MAIN TECHNICAL PARAMETER

Part No.	Switch Temperature($^{\circ}\text{C}$)	Resistance Value(Ω)	Rated Voltage(V)	Break down Voltage(V)
MZ3-L100RN	40 ± 5	100-2000	270	400~1000
MZ3-K100RN	60 ± 5	100-2500		
MZ3-M100RN	80 ± 5	100-4000		
MZ3-N100RN	100 ± 5	100-2000		
MZ3-P100RN	120 ± 5	100-2000		

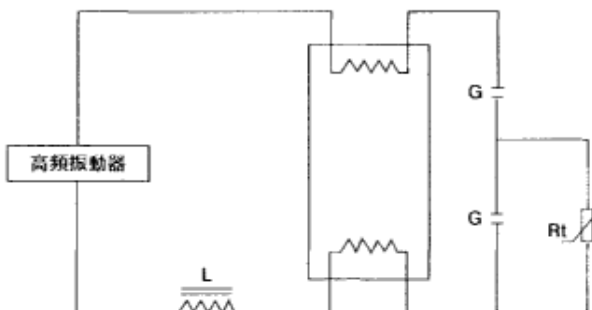

MZ2 TYPE THERMISTOR for Current-Limited

Features

Compact for telecommunication and AC circuit.

APPLICATION ENVIROMENTAL CONDITIONS

Environmental temperature: -10°C~+ 60°C

Relative humidity: 40~75%(+40°C±2°C)

Atmosphere pressure: 86~106KPa

DIMENSIONS(mm)

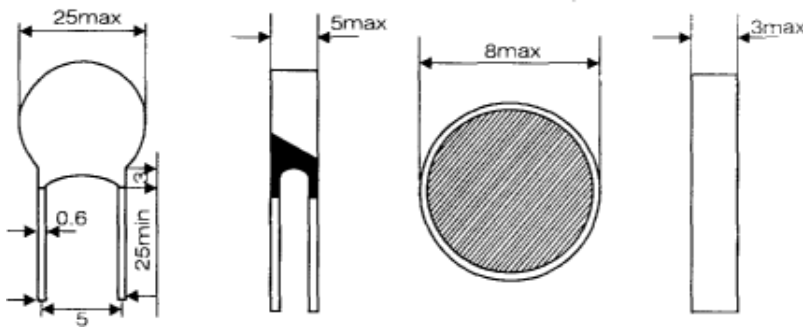

THE PARAMETER OF TRANSFORMER

Part No	Non-operating Current (mA)	Tip current (mA)	Rated Resistance (Ω)	Max Voltage (V)	Max Dimensions (mm)	Matched Transformer (W)
MZ21P4R7RM	390	900	4.7±20%	140	Φ19.0 x 6.0	35
MZ21P5R6RM	240	780	5.6±20%		Φ17.0x6.0	30
MZ21P6R8RM	290	670	68±20%		Φ14.0 x 6.0	25
MZ21P100RM	220	510	10±20%		Φ13.0 x 6.0	20
MZ21P150RM	170	400	15±20%		Φ11.6 x 6.0	15
MZ21 P220RM	140	330	22±20%		Φ9.6 x 6.0	10
MZ21P330RM	100	230	33±20%		Φ7.4 x 6.0	5
MZ21P120RM	150	610	12±20%		Φ19.5 x 6.0	35
MZ21P270RM	150	360	27±20%	270	Φ14.0x6.0	20
MZ21P390RM	100	240	39±20%		Φ10.0 x 6.0	15
MZ21P560RM	80	190	56±20%		Φ8.0 x 6.0	10
MZ21P820RM	60	150	82±20%		Φ8.0 x 6.0	10
MZ21P121RM	35	85	120±20%		Φ6.5 x 6.0	5
MZ21P181RM	29	70	180±20%		Φ6.5x6.0	3

Operating temperature range -10°C~+60°C

It means typical capacitance of the transformer which can be used.

APPLICATION CIRCUIT



THE PARAMETER OF TELECOMMUNICATION FACILITIES

Part No.	Nominal Resistance 25°C	Non-operating Current (mA)	Responding Time						Breakdown Voltage (VAC)	Current(time)		Dimensions (Max)
			3A 0.5 A	2A 0.5 A	1A 0.5 A	0.75 A 0.15 A	0.5A 0.15A	0.35 A 0.15 A		Power frequency Current 3A	Shock Current	
MZ21-8R0RM	8	150	0.4	0.8	3	10	25	70	250	20	10	Φ9x35
MZ21-120RM	12	110	0.3	0.45	1.5	5	15	20	250	20	10	Φ9 x 35
MZ21-180RM	18	110	0.2	0.35	1.2	5	15	20	250	20	10	Φ8 x 35
MZ21-400RM	40	50	0.1	0.2	0.6	1	3	20	360	20	10	Φ7.5 x 5
MZ21-500AM	50	50	0.1	0.3	0.6	1	3	20	420	20	10	Φ7.5x5
MZ21-B20RM	82	50	0.1	0.3	0.6	1	3	20	420	20	10	Φ7.5 x 5
MZ21101AM	100	50	0.15	0.25	0.6	1	2	3	420	20	10	Φ9.0x45
MZ22-8R0RM	8	150	0.4	0.5	3	10	25	70	250	20	10	10<9.0x5
MZ22-120RM	12	80	0.2	0.3	1.5	5	20	50	250	20	30	10 x 9.6 x 5
MZ22-180RM	18	110	0.2	0.35	1.2	5	15	20	250	20	30	10 x 0.6x5
MZ22-220RM	22	110	0.2	0.35	1.2	5	15	20	250	20	30	10 x 9.6x5
MZ22-270RM	27	90	0.1	0.2	0.5	0.8	2	4	420	20	30	10 x 9.6x5
MZ22-500RM	50	50	0.2	0.3	0.6	1	3	20	420	20	30	10 x 9.6x5
MZ23-80RM	8	150	0.4	0.8	3	10	25	70	250	20	30	Φ(7-9) x (1.6-2.5)
MZ23-120AM	12	130	0.3	0.5	2.5	7	20	50	250	20	30	Φ(7-9) x (1.6-2.5)
MZ23-180RM	18	110	0.2	0.35	1.2	5	15	20	250	20	30	Φ(6-9)x(1.6-2.5)
MZ23-220RM	22	110	0.2	0.35	1.2	5	15	20	250	20	30	Φ(6-8) x (1.6-2.5)
MZ23-270RM	27	90	0.1	0.2	0.5	0.8	2	4	250	20	30	Φ(6-8) x (1.6-2.5)

MZ21 MZ22: 10/1000μs. 1KV. 25A;
MZ23: 10/310μs. 1.5KV. 37.5A.

APPLICATION CIRCUIT

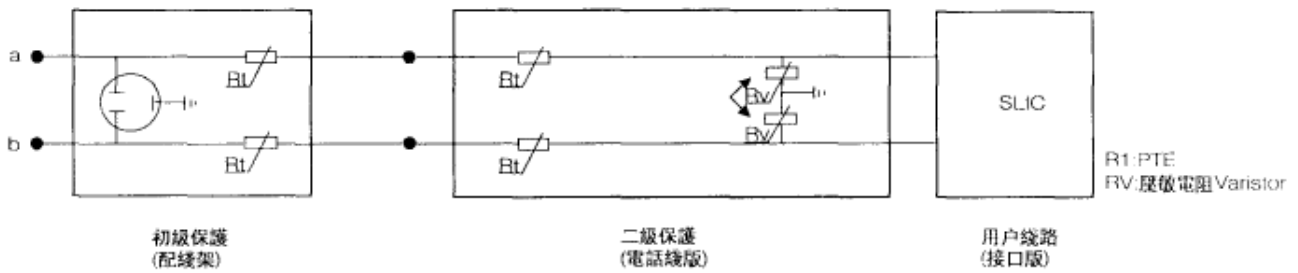

THE PARAMETER OF TRANSFORMER

Part No.	Non-operating Current (mA)	Tip Current (mA)	Rated resistance (Ω)	Rated Temperature ($^{\circ}\text{C}$)	Mzx Dimensions (mm)	Max Vaitago (V)
MZ21-M201RM	10	20	200	80	$\Phi 4 \times 5$	360
MZ21-M151RM	15	30	150		$\Phi 6.5 \times 5$	360
ML21-M101RM	40	80	100		$\Phi 8.5 \times 5$	360
MZ21-M500RM	50	100	50		$\Phi 8 \times 5$	270
MZ21-M100RM	130	260	10		$\Phi 8.5 \times 5$	270
MZ21-M150RM	150	300	15		$\Phi 10 \times 5$	270
MZ21-M100RM	180	360	10		$\Phi 15 \times 5$	270
MZ21-N201RM	15	30	200	100	$\Phi 4 \times 5$	270
MZ21-N151RM	30	60	150		$\Phi 6.5 \times 5$	270
MZ21-N101RM	50	100	100		$\Phi 5.5 \times 5$	270
MZ21-N820RM	80	160	82		$\Phi 8 \times 5$	270
MZ21-N150RM	150	300	15		$\Phi 13 \times 5$	270
MZ21-N100RM	180	360	10		$\Phi 15 \times 5$	270
MZ21-N8R0RM	200	400	8		$\Phi 15 \times 5$	270
MZ21-N5R0RM	250	500	5		$\Phi 18 \times 5$	270
MZ21-N3R0RM	400	800	3		$\Phi 25 \times 5$	270

Operating temperature range $-10^{\circ}\text{C} \sim +60^{\circ}\text{C}$

Application Circuit

(1) 晶體管電路

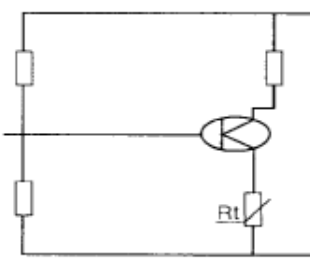

(A) 接在發射極電路

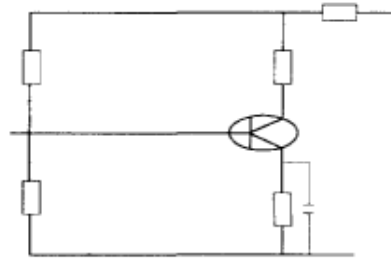

(b) 接在電源回路

(2) 電機保護

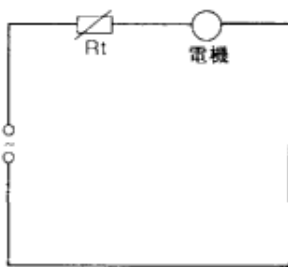

(3) 一般電器回路

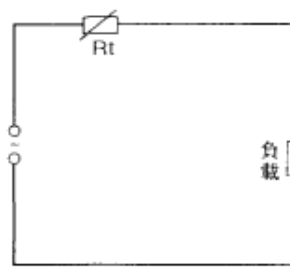

MZ7 TYPE THERMISTOR for Degaussing

FEATURES

Superior degaussing component of colour TV set and monitor.
Current-Limited unite in AC circuit.

APPLICATION ENVIROMENTAL CONDITIONS

Environmental temperature:-10°C ~ +85°C
Relative humidity:93±2%(+40°C ±2°C)
Vibration frequency 1 0~55Hz
Acceleration:98m/s²

DIMENSIONS

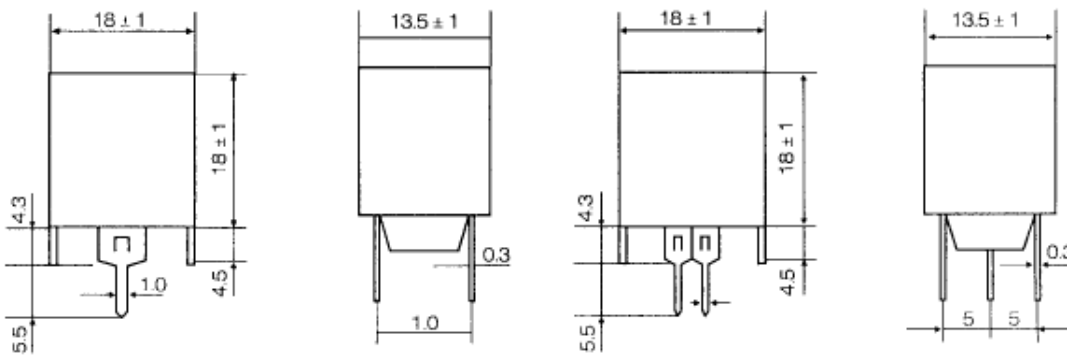

MAIN TECHNICAL Parameter

PartNo.	Resistance Value	Working Voltage	Max Voltage	(25°C) Current Attenuation Characteristic		
				I ₀ P-P(A)	I ₁ P-P(mA)3'	I ₂ rms(mA)60'
MZ72-7RM	7±20%	220	270	≥18	≤300	≤10
MZ72-9RM	9±20%	220	270	≥18	≤300	≤10
MZ72-12RM	12±20%	220	270	≥18	≤300	≤10
MZ72-14RM	14±20%	220	270	≥18	≤300	≤10
MZ72-18RM	18±20%	220	270	≥18	≤300	≤8
MZ72-20RM	20±20%	220	270	≥18	≤300	≤8
MZ73-7RM	7±20%	220	270	≥18	≤300	≤7
MZ73-9RM	9±20%	220	270	≥18	≤300	≤7
M773-12RM	12±20%	220	270	≥18	≤300	≤6
MZ73-14RM	14±20%	220	270	≥18	≤300	≤4
MZ73-18RM	18±20%	220	270	≥18	≤300	≤3
MZ73-27RM	27±20%	220	270	≥18	≤300	≤3
MZ73-36RM	36±20%	220	270	≥18	≤300	≤3

APPLICATION CIRCUIT

This is a basic degaussing circuit, if residual currents requested zero, this circuit usually a switch. When necessary the switch is turned off.

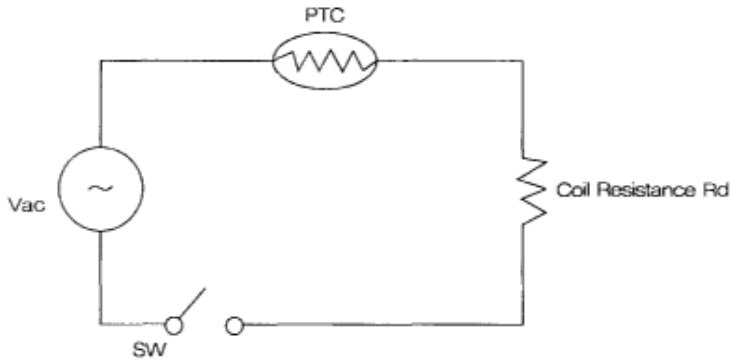

Current-Time Characteristic(Dynamic Characteristic)

Heating element (1) causes the resistance value of Element (2) to increase and make the stable current extremely small. Thus in many cases, the circuit is designed to be linked to the power switch so that degaussing is performed automatically when the power is turned on.

When excessive power is applied to the thermistor, a large current flows momentarily, then the self-heating feature of the thermistor causes the resistance value to increase and the current value to decrease. Thus, the thermistor controls the degaussing function ideally.

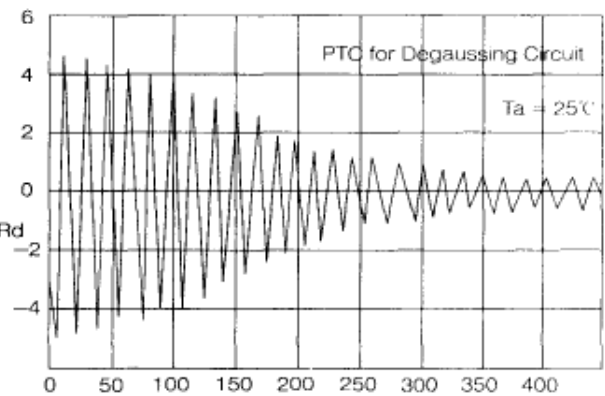
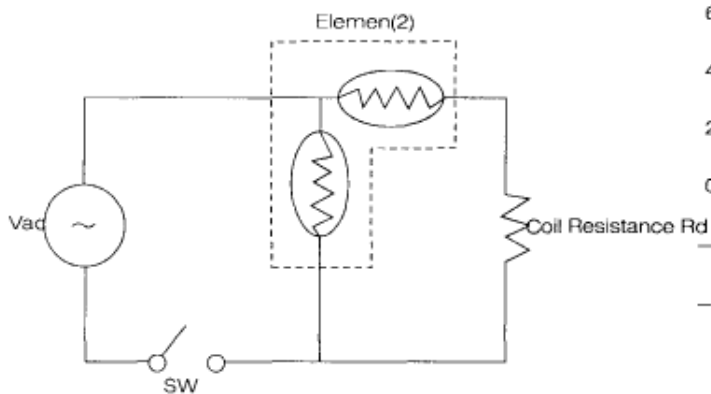

MZ4 TYPE THERMISTOR for Auto-Control-heat

FEATURES

- * Used as Auto Control Component on air conditioner, hot wind machine and Varies of heater
- * Used as Auto Control Component on small heater, rolling hair machine, driving mosquito machine.

APPLICATION ENVIROMENTAL CONDITIONS

- * Environmental temperature: -10°C~+85°C
- * Relative humidity:93 ± 2%(+40°C±2°C)
- * Vibration frequency:10~55Hz
- * Acceleration:98m/s²

MAIN TECHNICAL PARAMETER

Model	Specification(mm)	Properties			
		p(cm.Ω)	TC(°C)	a(%/°C)	Vb VAC/mm
MZ42-260	Φ4x15x2.5	>1.0 x 10 ²	260	≥16	≥250
MZ41-260	Φ21x2.5	>1.0 x 10 ²	260	≥16	≥250
MZ41-220	Φ13x2.5	>4.0 x 10	220	≥16	≥250
MZ41-215	Φ13x2.5	>4.0 x 10	215	≥16	≥250
MZ41-210	Φ13x2.5	>4.0 x 10	210	≥16	≥250

DIMENSIONS

